



07 PENDANTS

Pendants have timeless elegance and are available in a large range of classical and avant-garde cuts and shapes, as well as in many colors and effects. Pendants offer a whole range of design possibilities for different segments thanks to their easy application, with the hole on top requiring only a jump ring/ pinch bail with a chain, or cord. Because of the diverse range of sizes available, Pendants are ideal for creating jewelry sets such as necklace, bracelet, and earrings.

Pendants

Summary



Pendants



1 2 3

6000
 11x5.5, 13x6.5, 15x7.5,
 22x11, 28x14 mm

6002
 10x7, 15x11.5 mm

6007
 7x4, 9x5 mm

6010
 11x5.5, 13x6.5,
 17x8.5, 21x10.5,
 50x21.5 mm

6012
 11x10, 15.4x14 mm

6015
 13, 17, 21, 50 mm

6020
 18, 30, 37 mm

6039
 25, 38 mm

6040
 20, 30, 40 mm

6041
 18, 28, 38 mm



6049
 20, 30 mm

6090
 16x11, 22x15 mm

6091
 28, 38, 50 mm

1 2 3

6100
 24x12, 34x20 mm



6106
 16, 22, 28, 38, 50 mm

6110
 30x14, 40x18 mm

6128
 8, 10, 12 mm

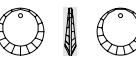

6150
 30, 50 mm

6191
 19, 27, 48 mm

6210
 12, 17 mm

6215
 18 mm

6225
 10, 18, 28 mm

6228
 10.3x10, 14.4x14,
 18x17.5, 28, 40 mm



6240
 12, 17, 27, 37 mm

6260
 17, 27, 37 mm

6261
 17, 27, 36 mm

1 2 3

6262
 17, 26, 34 mm

6263
 36 mm

6264
 18, 28, 36 mm

6320
 14, 19, 27 mm

6328
 6, 8, 10 mm

6401
 8, 12, 14 mm

6428
 6, 8, 12 mm

6460
 20 mm

6470
 32, 40, 48 mm

6525
 19, 28 mm

6620
 20, 30, 40 mm

6621
 18, 28 mm



6650
 22 mm

1 Front view 2 Side view 3 Back view

If "1 Front view" or "3 Back view" highlighted in grey: the surface effect is applied on the respective side.

If "2 Side view" highlighted in grey: not defined on which side the surface effect is applied (for all symmetric and some asymmetric articles).

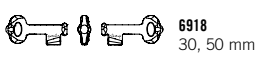
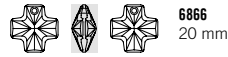
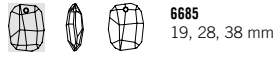
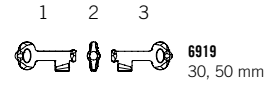
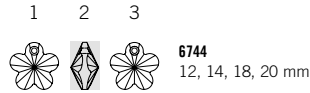
Pendants



1 Front view 2 Side view 3 Back view

If "1 Front view" or "3 Back view" highlighted in grey: the surface effect is applied on the respective side.

If "2 Side view" highlighted in grey: not defined on which side the surface effect is applied (for all symmetric and some asymmetric articles).

6721: 16, 20 mm: no defined side for surface effect; 28, 40 mm surface effect on "3 Back view".

6864: Reverse effect "V" is the standard version and therefore highlighted.



Pendants

6000



Size	11x5.5 mm	13x6.5 mm	15x7.5 mm	22x11 mm	28x14 mm
------	-----------	-----------	-----------	----------	----------

Color

Crystal (001)	■	■	■	■	■
Crystal AB (001 AB)	■	■	■	■	■
Crystal Blue Shade (001 BLSH)	■	■	■		
Jet (280)	■	■	■	■	
Amethyst (204)	■	■	■		
Aquamarine (202)	■				
Emerald (205)	■				
Light Siam (227)	■				
Light Turquoise (263)	■	■	■		
Rose (209)	■	■			
Sapphire (206)	■				
Siam (208)	■	■	■		
Tanzanite (539)	■	■	■		
Topaz (203)	■				

6002

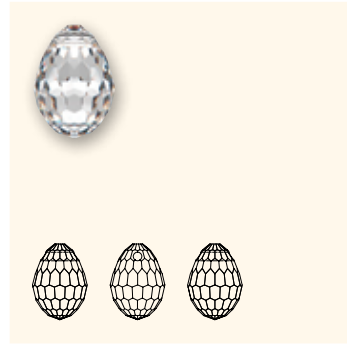

Size	10x7 mm	15x11.5 mm
------	---------	------------

Color

Crystal (001)	■	■
Crystal AB (001 AB)	■	■

6007 Small Briolette Pendant



Size	7x4 mm	9x5 mm
------	--------	--------

Color

Crystal (001)	■	■
Crystal AB (001 AB)	■	■
Crystal Golden Shadow (001 GSHA)	■	■
Crystal Moonlight (001 MOL)	■	
Crystal Silver Shade (001 SSHA)	■	■
Jet (280)	■	■
Light Rose (223)	■	■
Tanzanite (539)	■	

Pendants

6010 Briolette Pendant



Size	11x5.5 mm	13x6.5 mm	17x8.5 mm	21x10.5 mm	50x21.5 mm
------	-----------	-----------	-----------	------------	------------

Color	11x5.5 mm	13x6.5 mm	17x8.5 mm	21x10.5 mm	50x21.5 mm
Crystal (001)	■	■	■	■	■
Crystal AB (001 AB)	■	■	■	■	■
Crystal Antique Pink (001 ANTP)	■	■			
Crystal Astral Pink (001 API)	■	■			
Crystal Blue Shade (001 BLSH)	■	■			
Crystal Bronze Shade (001 BRSH)	■	■			
Crystal Copper (001 COP)	■	■	■	■	■
Crystal Golden Shadow (001 GSHA)	■	■	■	■	■
Crystal Luminous Green (001 LUMG)	■	■			
Crystal Moonlight (001 MOL)	■	■			
Crystal Silver Night (001 SINI)	■	■			
Crystal Silver Shade (001 SSHA)	■	■	■	■	■
Jet (280)	■	■			
Amethyst (204)	■	■	■		
Aquamarine (202)	■	■	■		
Chrysolite Opal (294)	■	■			
Cyclamen Opal (398)	■	■			
Dark Indigo (288)	■				
Denim Blue (266)	■	■			
Erinite (360)	■	■	■		
Fern Green (291)	■	■			
Fuchsia (502)	■	■	■		
Greige (284)	■	■			
Indian Pink (289)	■				
Jonquil (213)	■				
Light Amethyst (212)	■	■	■		
Light Colorado Topaz (246)	■	■	■		
Light Rose (223)	■	■	■		
Light Sapphire (211)	■	■			
Light Turquoise (263)	■	■			
Padparadscha (542)	■	■			
Peridot (214)	■	■			
Provence Lavender (283)	■	■			
Rose Peach (262)	■	■			
Sand Opal (287)	■	■			
Siam (208)	■	■			
Sunflower (292)	■	■			
Tanzanite (539)	■	■	■		



Size	11x5.5 mm	13x6.5 mm	17x8.5 mm	21x10.5 mm	50x21.5 mm
------	-----------	-----------	-----------	------------	------------

Crystal Blend Color	11x5.5 mm	13x6.5 mm	17x8.5 mm	21x10.5 mm	50x21.5 mm
Amethyst Blend (721)	■	■	■		
Burgundy-Blue Zircon Blend (723)	■	■			
Fern Green-Topaz Blend (724)	■	■			
Topaz Blend (722)	■	■	■		



Pendants

6012 Flat Briolette Pendant

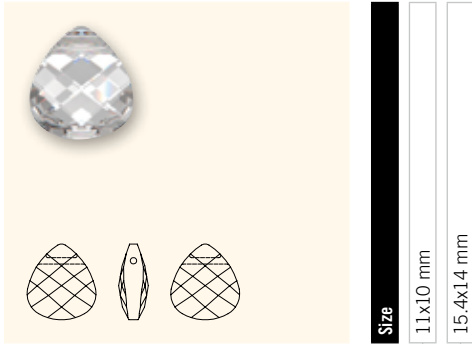

Color		Size	
Crystal (001)	<input type="checkbox"/>	11x10 mm	<input type="checkbox"/>
Crystal AB (001 AB)	<input type="checkbox"/>	15.4x14 mm	<input type="checkbox"/>
Crystal Golden Shadow (001 GSHA)	<input type="checkbox"/>		
Crystal Silver Shade (001 SSHA)	<input type="checkbox"/>		
Jet (280)	<input type="checkbox"/>		
Aquamarine (202)	<input type="checkbox"/>		
Light Rose (223)	<input type="checkbox"/>		
Olivine (228)	<input type="checkbox"/>		
Ruby (501)	<input type="checkbox"/>		

6015 Polygon Drop

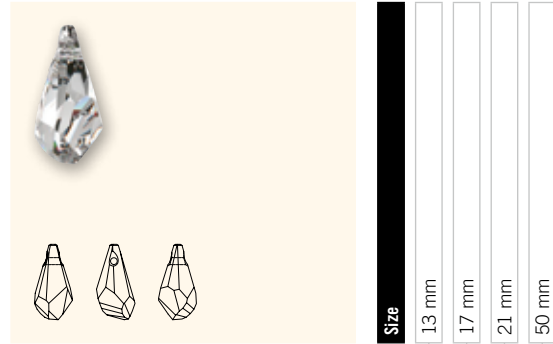

Color		Size			
Crystal (001)	<input type="checkbox"/>	13 mm	<input type="checkbox"/>	17 mm	<input type="checkbox"/>
Crystal AB (001 AB)	<input type="checkbox"/>		<input type="checkbox"/>	21 mm	<input type="checkbox"/>
Crystal Golden Shadow (001 GSHA)	<input type="checkbox"/>		<input type="checkbox"/>	50 mm	<input type="checkbox"/>
Crystal Silver Shade (001 SSHA)	<input type="checkbox"/>		<input type="checkbox"/>		
Jet (280)	<input type="checkbox"/>		<input type="checkbox"/>		
Amethyst (204)	<input type="checkbox"/>		<input type="checkbox"/>		
Aquamarine (202)	<input type="checkbox"/>		<input type="checkbox"/>		

6020 Helix Pendant

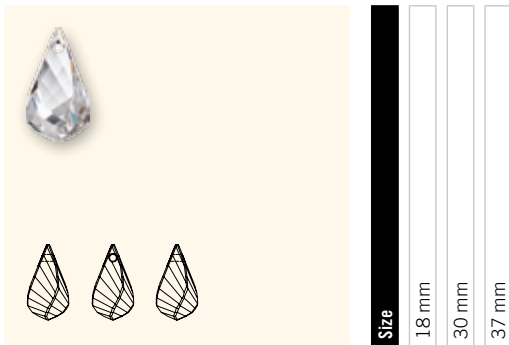

Color		Size		
Crystal (001)	<input type="checkbox"/>	18 mm	<input type="checkbox"/>	<input type="checkbox"/>
Crystal AB (001 AB)	<input type="checkbox"/>	30 mm	<input type="checkbox"/>	<input type="checkbox"/>
Crystal Golden Shadow (001 GSHA)	<input type="checkbox"/>		<input type="checkbox"/>	
Crystal Red Magma (001 REDM)	<input type="checkbox"/>		<input type="checkbox"/>	
Crystal Silver Shade (001 SSHA)	<input type="checkbox"/>		<input type="checkbox"/>	
Jet (280)	<input type="checkbox"/>		<input type="checkbox"/>	

6039 Disk Pendant

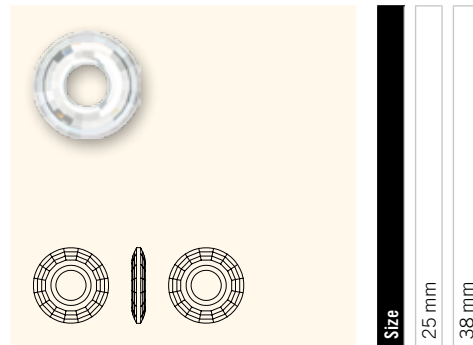

Color		Size	
Crystal (001)	<input type="checkbox"/>	25 mm	<input type="checkbox"/>
Crystal Astral Pink (001 API)	<input type="checkbox"/>	38 mm	<input type="checkbox"/>
Crystal Bermuda Blue P (001 BBL)*	<input type="checkbox"/>		
Crystal Bronze Shade (001 BRSH)	<input type="checkbox"/>		
Crystal Golden Shadow (001 GSHA)	<input type="checkbox"/>		
Crystal Luminous Green (001 LUMG)	<input type="checkbox"/>		
Crystal Red Magma (001 REDM)	<input type="checkbox"/>		
Crystal Silver Night (001 SINI)	<input type="checkbox"/>		
Crystal Silver Shade (001 SSHA)	<input type="checkbox"/>		
Crystal Tabac P (001 TAB)*	<input type="checkbox"/>		
Jet (280)	<input type="checkbox"/>		
Aquamarine (202)	<input type="checkbox"/>		

* For details about the „protective layer“ please refer to page 12.

Pendants

6040 Helios Pendant

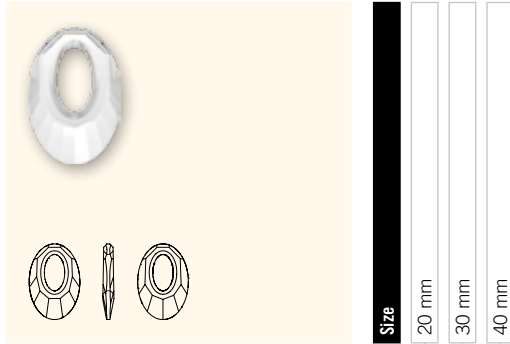

Color	20 mm	30 mm	40 mm
Crystal (001)	■	■	■
Crystal AB (001 AB)	■	■	■
Crystal Antique Pink (001 ANTP)	■	■	■
Crystal Astral Pink (001 API)	■	■	■
Crystal Blue Shade (001 BLSH)	■	■	■
Crystal Bronze Shade (001 BRSH)	■	■	■
Crystal Comet Argent Light V P (001 CAL V)*	■	■	■
Crystal Copper (001 COP)	■	■	■
Crystal Golden Shadow (001 GSHA)	■	■	■
Crystal Luminous Green (001 LUMG)	■	■	■
Crystal Red Magma (001 REDM)	■	■	■
Crystal Silver Night (001 SINI)	■	■	■
Crystal Silver Shade (001 SSHA)	■	■	■
Crystal Vitrail Medium P (001 VM)*	■	■	■
Jet (280)	■	■	■
Indicolite (379)	■	■	■
Olivine (228)	■	■	■

6041 Victory Pendant

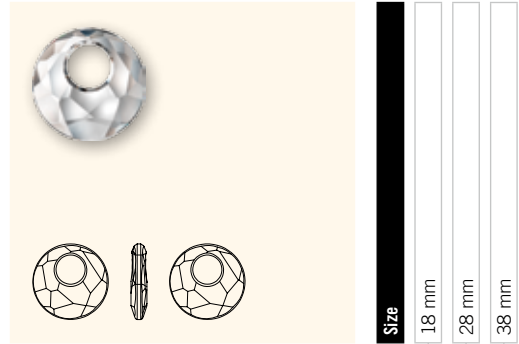

Color	18 mm	28 mm	38 mm
Crystal (001)	■	■	■
Crystal AB (001 AB)	■	■	■
Crystal Antique Pink (001 ANTP)	■	■	■
Crystal Bronze Shade (001 BRSH)	■	■	■
Crystal Golden Shadow (001 GSHA)	■	■	■
Crystal Satin (001 SAT)	■	■	■
Crystal Red Magma (001 REDM)	■	■	■
Jet (280)	■	■	■
Aquamarine (202)	■	■	■

6049

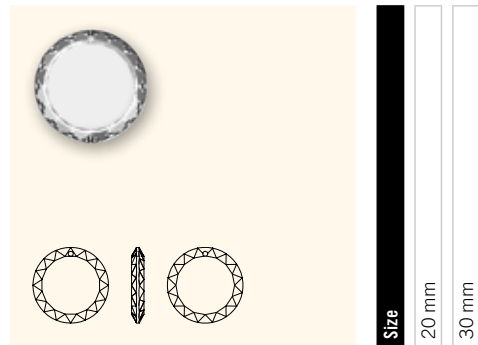

Color	20 mm	30 mm
Crystal (001)	■	■

* For details about the „protective layer“ please refer to page 12.

Pendants

6090 Baroque Pendant

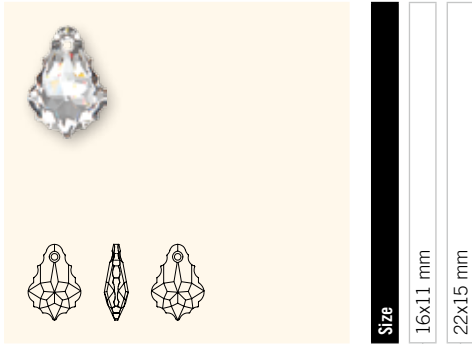

Size

16x11 mm

22x15 mm

Color

Crystal (001)	<input type="checkbox"/>	<input type="checkbox"/>
Crystal AB (001 AB)	<input type="checkbox"/>	<input type="checkbox"/>
Crystal Golden Shadow (001 GSHA)	<input type="checkbox"/>	<input type="checkbox"/>
Jet (280)	<input type="checkbox"/>	<input type="checkbox"/>
Amethyst (204)	<input type="checkbox"/>	<input type="checkbox"/>
Aquamarine (202)	<input type="checkbox"/>	<input type="checkbox"/>
Black Diamond (215)	<input type="checkbox"/>	<input type="checkbox"/>
Light Amethyst (212)	<input type="checkbox"/>	<input type="checkbox"/>
Light Colorado Topaz (246)	<input type="checkbox"/>	<input type="checkbox"/>
Light Rose (223)	<input type="checkbox"/>	<input type="checkbox"/>
Light Topaz (226)	<input type="checkbox"/>	<input type="checkbox"/>
Olivine (228)	<input type="checkbox"/>	<input type="checkbox"/>
Ruby (501)	<input type="checkbox"/>	<input type="checkbox"/>

6091 Flat Baroque Pendant

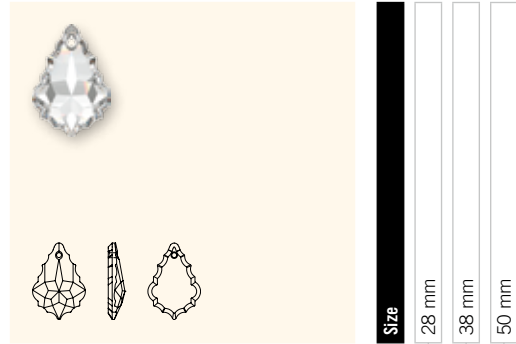

Size

28 mm

38 mm

50 mm

Color

Crystal (001)	<input type="checkbox"/>	<input type="checkbox"/>	<input type="checkbox"/>
Print			
Crystal (001)	<input type="checkbox"/>	<input type="checkbox"/>	<input type="checkbox"/>
Paisley Print		<input type="checkbox"/>	<input type="checkbox"/>
Print			
Crystal (001)	<input type="checkbox"/>	<input type="checkbox"/>	<input type="checkbox"/>
Ivy Print		<input type="checkbox"/>	<input type="checkbox"/>
Crystal AB (001 AB)	<input type="checkbox"/>	<input type="checkbox"/>	<input type="checkbox"/>
Crystal Golden Shadow (001 GSHA)	<input type="checkbox"/>	<input type="checkbox"/>	<input type="checkbox"/>

6100



Size

24x12 mm

34x20 mm

Color

Crystal (001)	<input type="checkbox"/>	<input type="checkbox"/>
Crystal AB (001 AB)	<input type="checkbox"/>	<input type="checkbox"/>
Crystal Bermuda Blue (001 BBL)	<input type="checkbox"/>	<input type="checkbox"/>
Crystal Vitrail Light (001 VL)	<input type="checkbox"/>	<input type="checkbox"/>
Crystal Vitrail Medium (001 VM)	<input type="checkbox"/>	<input type="checkbox"/>
Fireopal (237)	<input type="checkbox"/>	<input type="checkbox"/>

Pendants

6106 Pear-shaped Pendant



Size	16 mm	22 mm	28 mm	38 mm	50 mm
------	-------	-------	-------	-------	-------

Color	16 mm	22 mm	28 mm	38 mm	50 mm
Crystal (001)	■	■	■	■	■
Crystal AB (001 AB)	■	■	■		
Crystal Antique Pink (001 ANTP)	■	■	■		
Crystal Astral Pink (001 API)	■	■	■		
Crystal Blue Shade (001 BLSH)	■	■	■		
Crystal Bronze Shade (001 BRSH)	■	■	■		
Crystal Copper (001 COP)	■	■			
Crystal Golden Shadow (001 GSHA)	■	■	■	■	■
Crystal Luminous Green (001 LUMG)	■	■	■		
Crystal Red Magma (001 REDM)	■	■			
Crystal Silver Night (001 SINI)	■	■	■		
Crystal Silver Shade (001 SSHA)	■	■	■	■	■
Jet (280)	■	■	■		
Aquamarine (202)	■	■			
Light Rose (223)	■	■			
Peridot (214)	■	■			
Ruby (501)	■				
Tanzanite (539)	■	■			
Crystal Blend Color					
Amethyst Blend (721)	■	■			
Burgundy-Blue Zircon Blend (723)	■	■			
Fern Green-Topaz Blend (724)	■	■			
Topaz Blend (722)	■	■			

6110 Navette Pendant

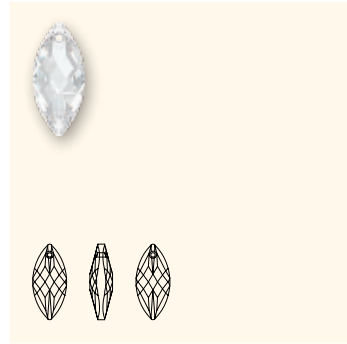

Size	30x14 mm	40x18 mm
------	----------	----------

Color	30x14 mm	40x18 mm
Crystal (001)	■	■
Crystal Golden Shadow (001 GSHA)	■	■
Crystal Red Magma (001 REDM)	■	■
Crystal Silver Shade (001 SSHA)	■	■
Jet (280)	■	■
Amethyst (204)		■
Aquamarine (202)		■
Light Amethyst (212)		■
Olivine (228)		■



Pendants

6128 XILION Mini Pear Pendant

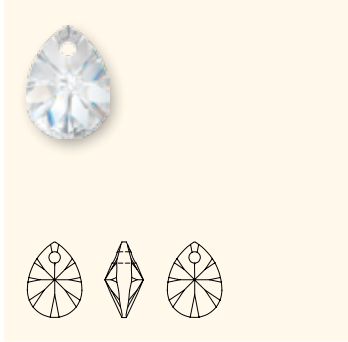

Size	8 mm	10 mm	12 mm
------	------	-------	-------

Color

Crystal (001)	■	■	■
Crystal AB (001 AB)	■	■	■
Crystal Astral Pink (001 API)	■	■	■
Crystal Bronze Shade (001 BRSH)	■	■	■
Crystal Copper (001 COP)	■	■	■
Crystal Golden Shadow (001 GSHA)	■	■	■
Crystal Silver Shade (001 SSHA)	■	■	■
Jet (280)	■	■	■
Aquamarine (202)	■	■	■
Denim Blue (266)	■	■	■
Light Siam (227)	■	■	■
Light Topaz (226)	■	■	■
Peridot (214)	■	■	■
Rosaline (508)	■	■	■
Rose Peach (262)	■	■	■
Tanzanite (539)	■	■	■

6150 Pegasus Pendant

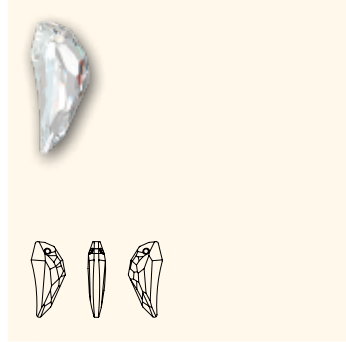

Size	30 mm	50 mm
------	-------	-------

Color

Crystal (001)	■	■
Crystal Antique Pink (001 ANTP)	■	■
Crystal Astral Pink (001 API)	■	■
Crystal Golden Shadow (001 GSHA)	■	■
Crystal Luminous Green (001 LUMG)	■	■
Crystal Moonlight (001 MOL)	■	■
Crystal Satin (001 SAT)	■	■
Crystal Silver Shade (001 SSHA)	■	■
Jet (280)	■	■

Pendants

6191 Divine Rock Pendant



Color		19 mm	27 mm	48 mm
	Crystal (001)	■	■	■
	Crystal Golden Shadow (001 GSXA)	■	■	■
	Crystal Luminous Green (001 LUMG)	■	■	■
	Crystal Red Magma (001 REDM)	■	■	■
	Crystal Silver Shade (001 SSHA)	■	■	■

6210

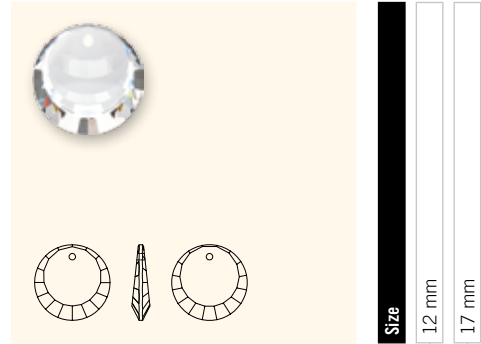

Color		12 mm	17 mm
	Crystal (001)	■	■
	Crystal AB (001 AB)	■	■

6215

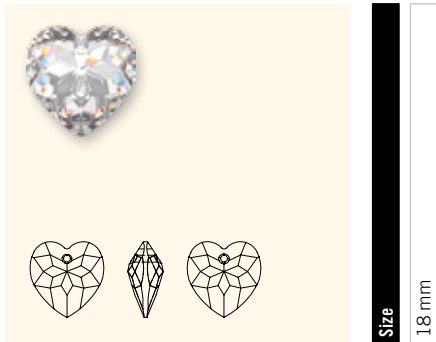

Color		18 mm
	Crystal (001)	■
	Crystal AB (001 AB)	■
	Crystal Astral Pink (001 API)	■
	Crystal Bermuda Blue P (001 BBL)*	■
	Crystal Red Magma (001 REDM)	■
	Crystal Satin (001 SAT)	■

6225

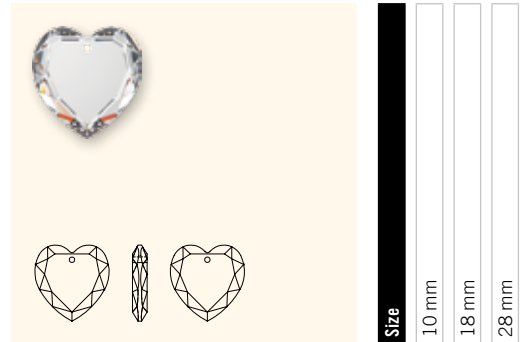

Color		10 mm	18 mm	28 mm
	Crystal (001)	■	■	■

* For details about the „protective layer“ please refer to page 12.

Pendants

6228 XILION Heart Pendant



Size	10.3x10 mm	14.4x14 mm	18x17.5 mm	28 mm	40 mm
------	------------	------------	------------	-------	-------

Color

Crystal (001)	■	■	■	■	■
Crystal AB (001 AB)	■	■	■	■	■
Crystal Antique Pink (001 ANTP)	■	■	■		
Crystal Astral Pink (001 API)	■	■	■	■	
Crystal Bermuda Blue (001 BBL)	■	■	■		
Crystal Bermuda Blue P (001 BBL)*				■	
Crystal Blue Shade (001 BLSH)	■	■	■	■	
Crystal Bronze Shade (001 BRSH)	■	■	■	■	
Crystal Golden Shadow (001 GSHA)	■	■	■	■	■
Crystal Heliotrope (001 HEL)	■	■	■		
Crystal Luminous Green (001 LUMG)	■	■	■	■	
Crystal Moonlight (001 MOL)	■	■	■		
Crystal Red Magma (001 REDM)	■	■	■	■	■
Crystal Silver Night (001 SINI)	■	■	■	■	
Crystal Silver Shade (001 SSHA)	■	■	■		
Crystal Vitrail Light (001 VL)	■	■	■		
Crystal Vitrail Medium (001 VM)	■	■	■		
Jet (280)	■	■	■		
Air Blue Opal (285)	■	■			
Amethyst (204)	■	■	■		
Amethyst AB (204 AB)	■	■	■		
Aquamarine (202)	■	■	■		
Aquamarine AB (202 AB)	■	■	■		
Black Diamond (215)	■	■	■		
Black Diamond AB (215 AB)	■	■	■		
Blue Zircon (229)	■	■	■		
Blue Zircon AB (229 AB)	■	■	■		
Chrysolite Opal (294)	■	■			
Cyclamen Opal (398)	■	■			
Dark Indigo (288)	■	■	■		
Denim Blue (266)	■	■	■		
Emerald (205)	■	■	■		
Fern Green (291)	■	■	■		
Fuchsia (502)	■	■	■		
Fuchsia AB (502 AB)	■				
Greige (284)	■	■			
Indian Pink (289)	■	■			
Jonquil (213)	■				
Light Amethyst (212)	■	■	■		



Size	10.3x10 mm	14.4x14 mm	18x17.5 mm	28 mm	40 mm
------	------------	------------	------------	-------	-------

Color

Light Rose (223)	■	■	■		
Light Rose AB (223 AB)	■	■	■		
Light Sapphire (211)	■	■	■	■	
Light Siam (227)	■	■	■		
Light Siam AB (227 AB)	■				
Light Topaz (226)	■	■	■	■	■
Light Topaz AB (226 AB)	■	■	■		
Light Turquoise (263)	■	■	■		
Olivine (228)	■				
Olivine AB (228 AB)	■				
Padparadscha (542)	■				
Peridot (214)	■	■	■		
Peridot AB (214 AB)	■	■	■		
Provence Lavender (283)	■	■	■		
Rosaline (508)	■	■	■	■	■
Rose (209)	■	■	■		
Rose AB (209 AB)	■	■	■		
Rose Peach (262)	■	■	■		
Sapphire (206)	■	■	■		
Sapphire AB (206 AB)	■				
Siam (208)	■	■	■		
Siam AB (208 AB)	■	■	■		
Sunflower (292)	■	■	■		
Tanzanite (539)	■	■			
Topaz (203)	■	■	■		
Violet (371)	■	■	■	■	■
Violet AB (371 AB)	■				
White Opal (234)	■	■	■		
Crystal Blend Color					
Amethyst Blend (721)	■	■	■		
Topaz Blend (722)	■	■	■		

* For details about the „protective layer“ please refer to page 12.

Pendants

6240 Wild Heart Pendant

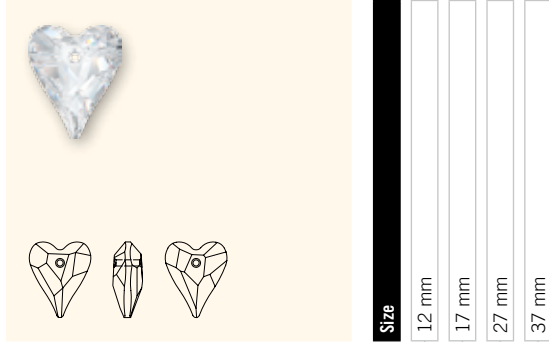

Color	12 mm	17 mm	27 mm	37 mm
Crystal (001)	■	■	■	■
Crystal AB (001 AB)	■	■	■	■
Crystal Antique Pink (001 ANTP)	■	■	■	■
Crystal Astral Pink (001 API)	■	■	■	■
Crystal Blue Shade (001 BLSH)	■	■	■	■
Crystal Comet Argent Light V P (001 CAL V)*	■	■	■	■
Crystal Copper (001 COP)	■	■	■	■
Crystal Golden Shadow (001 GSHA)	■	■	■	■
Crystal Luminous Green (001 LUMG)	■	■	■	■
Crystal Red Magma (001 REDM)	■	■	■	■
Crystal Silver Shade (001 SSHA)	■	■	■	■
Crystal Vitrail Medium P (001 VM)*	■	■	■	■
Jet (280)	■	■	■	■
Aquamarine (202)	■	■	■	■
Black Diamond (215)	■	■	■	■
Dark Indigo (288)	■	■	■	■
Indian Pink (289)	■	■	■	■
Light Rose (223)	■	■	■	■
Rosaline (508)	■	■	■	■
Sunflower (292)	■	■	■	■
Tanzanite (539)	■	■	■	■

6260 Crazy 4 U Heart



Color	17 mm	27 mm	37 mm
Crystal (001)	■	■	■
Crystal AB (001 AB)	■	■	■
Crystal Antique Pink (001 ANTP)	■	■	■
Crystal Astral Pink (001 API)	■	■	■
Crystal Golden Shadow (001 GSHA)	■	■	■
Crystal Red Magma (001 REDM)	■	■	■
Crystal Satin (001 SAT)	■	■	■
Jet (280)	■	■	■
Amethyst (204)	■	■	■
Aquamarine (202)	■	■	■
Rosaline (508)	■	■	■

* For details about the „protective layer“ please refer to page 12.



Pendants

6261 Devoted 2 U Heart



Size	17 mm	27 mm	36 mm
------	-------	-------	-------

Color		17 mm	27 mm	36 mm
Crystal (001)		■	■	■
Crystal AB (001 AB)		■	■	■
Crystal Antique Pink (001 ANTP)		■	■	■
Crystal Astral Pink (001 API)		■	■	■
Crystal Bermuda Blue P (001 BBL)*				■
Crystal Blue Shade (001 BLSH)		■	■	■
Crystal Comet Argent Light V P (001 CAL V)*		■	■	■
Crystal Golden Shadow (001 GSHA)		■	■	
Crystal Red Magma (001 REDM)		■	■	■
Crystal Satin (001 SAT)		■	■	
Crystal Vitrail Medium P (001 VM)*		■	■	■
Jet (280)		■	■	
Amethyst (204)		■		
Aquamarine (202)		■		
Rosaline (508)		■		

6262 Miss U Heart



Size	17 mm	26 mm	34 mm
------	-------	-------	-------

Color		17 mm	26 mm	34 mm
Crystal (001)		■	■	■
Crystal AB (001 AB)		■	■	■
Crystal Antique Pink (001 ANTP)		■	■	■
Crystal Astral Pink (001 API)		■	■	■
Crystal Golden Shadow (001 GSHA)		■	■	
Crystal Red Magma (001 REDM)		■	■	
Crystal Satin (001 SAT)		■	■	
Jet (280)		■	■	
Amethyst (204)		■		
Aquamarine (202)		■		
Rosaline (508)		■		

6263 Forever 1 Heart



Size	36 mm
------	-------

Color		36 mm
Crystal (001)		■
Crystal AB (001 AB)		■
Crystal Antique Pink (001 ANTP)		■
Crystal Astral Pink (001 API)		■
Crystal Bermuda Blue P (001 BBL)*		■
Crystal Satin (001 SAT)		■

* For details about the „protective layer“ please refer to page 12.

Pendants

6264 Truly in Love Heart



Color	18 mm	28 mm	36 mm
Crystal (001)	■	■	■
Crystal AB (001 AB)	■	■	■
Crystal Antique Pink (001 ANTP)	■	■	■
Crystal Astral Pink (001 API)	■	■	■
Crystal Bermuda Blue P (001 BBL)*		■	■
Crystal Golden Shadow (001 GSHA)	■	■	
Crystal Red Magma (001 REDM)	■	■	
Crystal Satin (001 SAT)	■	■	
Jet (280)	■	■	
Amethyst (204)	■		
Aquamarine (202)	■		
Rosaline (508)	■		

6320 Rhombus Pendant

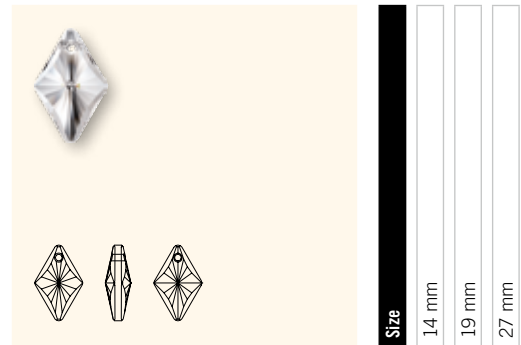

Color	14 mm	19 mm	27 mm
Crystal (001)	■	■	■
Crystal AB (001 AB)	■	■	■
Crystal Golden Shadow (001 GSHA)	■	■	■
Crystal Red Magma (001 REDM)	■	■	■
Crystal Silver Shade (001 SSHA)	■	■	■
Jet (280)	■	■	■

* For details about the „protective layer“ please refer to page 12.

Pendants

6328 XILION Bi-Cone Pendant

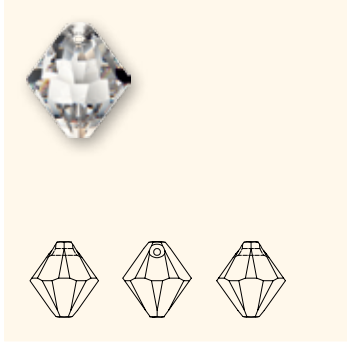

Size	6 mm	8 mm	10 mm
------	------	------	-------

Color

Crystal (001)	■	■	■
Crystal AB (001 AB)	■	■	■
Crystal Blue Shade (001 BLSH)	■	■	
Crystal Copper (001 COP)	■	■	■
Crystal Golden Shadow (001 GSHA)	■	■	■
Crystal Red Magma (001 REDM)	■	■	■
Crystal Silver Shade (001 SSHA)	■	■	■
Jet (280)	■	■	
Amethyst (204)	■	■	
Aquamarine (202)	■	■	
Black Diamond (215)	■	■	
Dark Indigo (288)	■	■	
Fern Green (291)	■	■	
Jonquil (213)	■	■	
Light Amethyst (212)	■	■	
Light Colorado Topaz (246)	■	■	
Light Rose (223)	■	■	
Light Sapphire (211)	■		
Light Turquoise (263)	■	■	
Peridot (214)	■	■	
Provence Lavender (283)	■	■	
Rose (209)	■	■	
Tanzanite (539)	■	■	
Violet (371)	■	■	

6401 Octagon Pendant

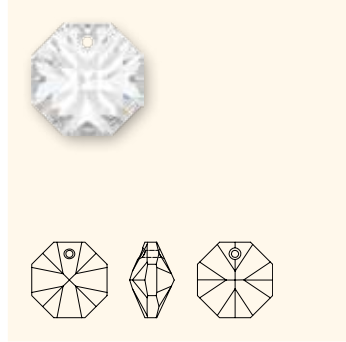

Size	8 mm	12 mm	14 mm
------	------	-------	-------

Color

Crystal (001)	■	■	■
Crystal AB (001 AB)		■	■
Crystal Copper (001 COP)	■		
Crystal Golden Shadow (001 GSHA)	■	■	
Crystal Silver Shade (001 SSHA)	■	■	
Jet (280)	■		
Aquamarine (202)	■		
Light Rose (223)	■		
Tanzanite (539)	■		

Pendants

6428 XILION Pendant

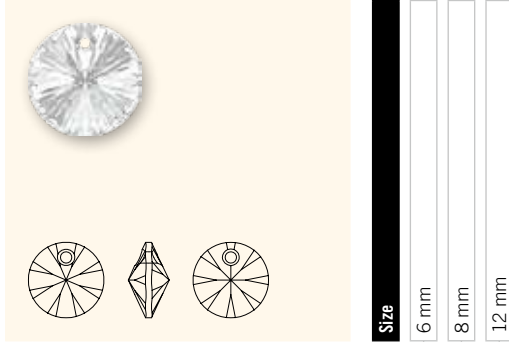

Color	6 mm	8 mm	12 mm
Crystal (001)	■	■	■
Crystal AB (001 AB)	■	■	■
Crystal Antique Pink (001 ANTP)	■	■	■
Crystal Astral Pink (001 API)	■	■	■
Crystal Blue Shade (001 BLSH)	■	■	
Crystal Bronze Shade (001 BRSH)	■	■	
Crystal Golden Shadow (001 GSHA)	■	■	■
Crystal Luminous Green (001 LUMG)	■	■	■
Crystal Metallic Light Gold 2x (001 MLG2)	■	■	
Crystal Silver Night (001 SINI)	■	■	
Crystal Silver Shade (001 SSHA)	■	■	■
Jet (280)	■	■	■
Amethyst (204)	■	■	
Aquamarine (202)	■	■	
Chrysolite (238)	■	■	
Chrysolite Opal (294)	■	■	
Cyclamen Opal (398)	■	■	
Dark Indigo (288)	■	■	
Denim Blue (266)	■	■	
Fern Green (291)	■	■	
Greige (284)	■	■	
Indian Pink (289)	■	■	
Light Colorado Topaz (246)	■	■	
Light Siam (227)	■	■	
Light Turquoise (263)	■	■	
Provence Lavender (283)	■	■	
Rose (209)	■	■	
Rose Peach (262)	■	■	
Siam (208)	■	■	
Sunflower (292)	■	■	
Violet (371)	■	■	

6460 Column Pendant

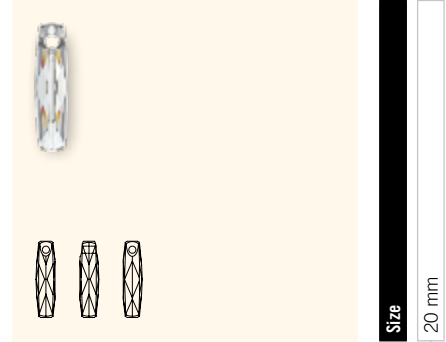

Color	20 mm
Crystal (001)	■
Crystal AB (001 AB)	■
Crystal Copper (001 COP)	■
Crystal Golden Shadow (001 GSHA)	■
Crystal Satin (001 SAT)	■
Crystal Silver Shade (001 SSHA)	■



Pendants

6470 Ellipse Pendant

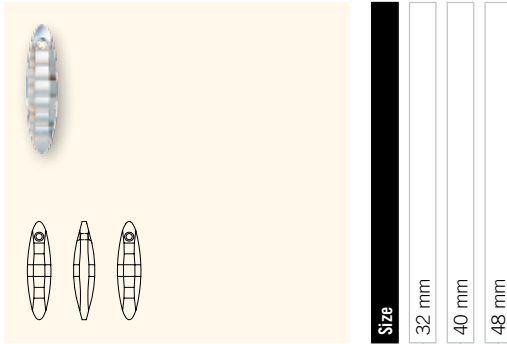

Size
32 mm
40 mm
48 mm

Color				
	Crystal (001)	■	■	■
	Crystal AB (001 AB)	■	■	■
	Crystal Astral Pink (001 API)	■	■	■
	Crystal Golden Shadow (001 GSHA)	■	■	■
	Crystal Red Magma (001 REDM)	■	■	■
	Crystal Satin (001 SAT)	■	■	■
	Crystal Silver Shade (001 SSHA)	■	■	■
	Jet (280)	■	■	■
	Aquamarine (202)	■	■	
	Light Amethyst (212)	■	■	
	Light Colorado Topaz (246)	■	■	
	Olivine (228)	■	■	

6525 Wave Pendant

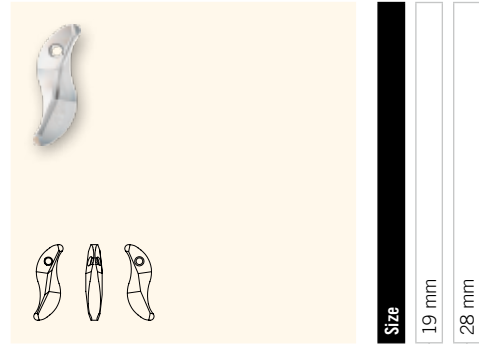

Size
19 mm
28 mm

Color				
	Crystal (001)	■	■	
	Crystal AB (001 AB)	■	■	
	Crystal Antique Pink (001 ANTP)	■	■	
	Crystal Astral Pink (001 API)	■	■	
	Crystal Blue Shade (001 BLSH)	■	■	
	Crystal Golden Shadow (001 GSHA)	■	■	
	Crystal Luminous Green (001 LUMG)	■	■	
	Crystal Red Magma (001 REDM)	■	■	
	Crystal Silver Night (001 SINI)	■	■	
	Jet (280)	■	■	
	Amethyst (204)	■	■	
	Aquamarine (202)	■	■	
	Denim Blue (266)	■	■	

Pendants

6620 Avant-garde Pendant

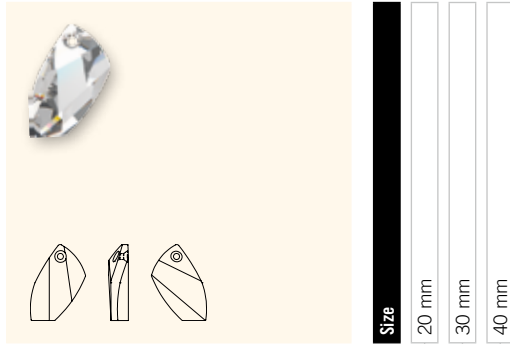

Color		20 mm	30 mm	40 mm
Crystal (001)		■	■	■
Print				
Crystal (001)				■
Zebra Print				■
Print				
Crystal (001)				■
Paisley Print				■
Crystal AB (001 AB)		■		
Crystal Astral Pink (001 API)		■	■	■
Crystal Golden Shadow (001 GSHA)		■	■	■
Crystal Silver Shade (001 SSHA)		■		■
Indicolite (379)		■		

6621 Twist Pendant

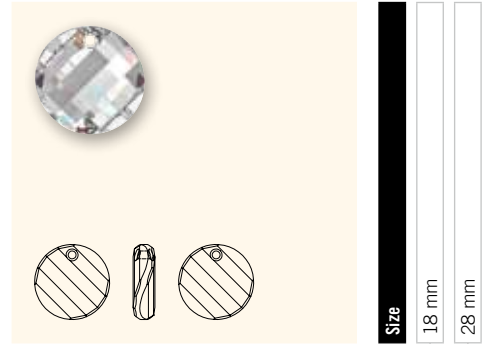

Color		18 mm	28 mm
Crystal (001)		■	■
Crystal Astral Pink (001 API)		■	■
Crystal Bermuda Blue P (001 BBL)*		■	■
Crystal Blue Shade (001 BLSH)		■	■
Crystal Comet Argent Light V P (001 CAL V)*		■	■
Crystal Golden Shadow (001 GSHA)		■	■
Crystal Luminous Green (001 LUMG)		■	■
Crystal Moonlight (001 MOL)		■	■
Crystal Red Magma (001 REDM)		■	■
Crystal Silver Night (001 SINI)		■	■
Crystal Silver Shade (001 SSHA)		■	■
Crystal Tabac P (001 TAB)*		■	■
Crystal Vitrail Medium P (001 VM)*		■	■
Jet (280)		■	■
Amethyst (204)		■	■
Aquamarine (202)		■	■
Black Diamond (215)		■	■
Peridot (214)		■	■

Pendants



* For details about the „protective layer“ please refer to page 12.

Pendants

6650 Cubist Pendant

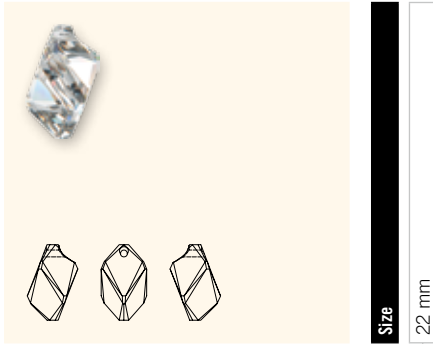

Color	
Crystal (001)	<input type="checkbox"/>
Crystal Copper (001 COP)	<input type="checkbox"/>
Crystal Golden Shadow (001 GSHA)	<input type="checkbox"/>
Crystal Moonlight (001 MOL)	<input type="checkbox"/>
Crystal Silver Shade (001 SSHA)	<input type="checkbox"/>
Jet (280)	<input type="checkbox"/>
Black Diamond (215)	<input type="checkbox"/>
Burgundy (515)	<input type="checkbox"/>
Light Amethyst (212)	<input type="checkbox"/>
Light Sapphire (211)	<input type="checkbox"/>
Peridot (214)	<input type="checkbox"/>

6656 Galactic Vertical Pendant

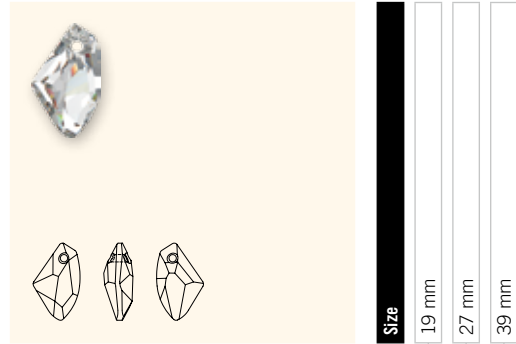

Color		19 mm	27 mm	39 mm
Crystal (001)	<input type="checkbox"/>	<input type="checkbox"/>	<input type="checkbox"/>	<input type="checkbox"/>
Crystal Antique Pink (001 ANTP)	<input type="checkbox"/>	<input type="checkbox"/>	<input type="checkbox"/>	<input type="checkbox"/>
Crystal Astral Pink (001 API)	<input type="checkbox"/>	<input type="checkbox"/>	<input type="checkbox"/>	<input type="checkbox"/>
Crystal Bermuda Blue P (001 BBL)*	<input type="checkbox"/>	<input type="checkbox"/>	<input type="checkbox"/>	<input type="checkbox"/>
Crystal Blue Shade (001 BLSH)	<input type="checkbox"/>	<input type="checkbox"/>	<input type="checkbox"/>	<input type="checkbox"/>
Crystal Bronze Shade (001 BRSH)	<input type="checkbox"/>	<input type="checkbox"/>	<input type="checkbox"/>	<input type="checkbox"/>
Crystal Comet Argent Light V P (001 CAL V)*	<input type="checkbox"/>	<input type="checkbox"/>	<input type="checkbox"/>	<input type="checkbox"/>
Crystal Golden Shadow (001 GSHA)	<input type="checkbox"/>	<input type="checkbox"/>	<input type="checkbox"/>	<input type="checkbox"/>
Crystal Luminous Green (001 LUMG)	<input type="checkbox"/>	<input type="checkbox"/>	<input type="checkbox"/>	<input type="checkbox"/>
Crystal Moonlight (001 MOL)	<input type="checkbox"/>	<input type="checkbox"/>	<input type="checkbox"/>	<input type="checkbox"/>
Crystal Red Magma (001 REDM)	<input type="checkbox"/>	<input type="checkbox"/>	<input type="checkbox"/>	<input type="checkbox"/>
Crystal Silver Shade (001 SSHA)	<input type="checkbox"/>	<input type="checkbox"/>	<input type="checkbox"/>	<input type="checkbox"/>
Crystal Tabac P (001 TAB)*	<input type="checkbox"/>	<input type="checkbox"/>	<input type="checkbox"/>	<input type="checkbox"/>
Crystal Vitrail Medium P (001 VM)	<input type="checkbox"/>	<input type="checkbox"/>	<input type="checkbox"/>	<input type="checkbox"/>
Jet (280)	<input type="checkbox"/>	<input type="checkbox"/>	<input type="checkbox"/>	<input type="checkbox"/>
Aquamarine (202)	<input type="checkbox"/>	<input type="checkbox"/>	<input type="checkbox"/>	<input type="checkbox"/>
Light Rose (223)	<input type="checkbox"/>	<input type="checkbox"/>	<input type="checkbox"/>	<input type="checkbox"/>
Peridot (214)	<input type="checkbox"/>	<input type="checkbox"/>	<input type="checkbox"/>	<input type="checkbox"/>
Tanzanite (539)	<input type="checkbox"/>	<input type="checkbox"/>	<input type="checkbox"/>	<input type="checkbox"/>

* For details about the „protective layer“ please refer to page 12.

Pendants

6670 De-Art Pendant

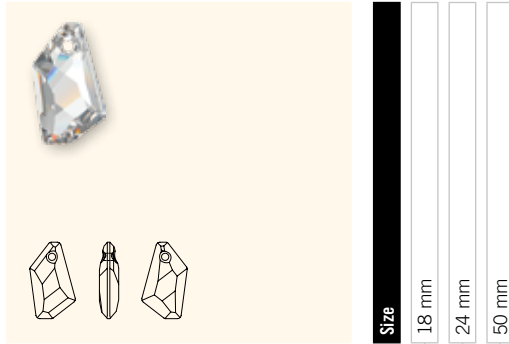

Color	18 mm	24 mm	50 mm
Crystal (001)	■	■	■
Crystal AB (001 AB)	■	■	■
Crystal Antique Pink (001 ANTP)	■	■	■
Crystal Astral Pink (001 API)	■	■	■
Crystal Bermuda Blue P (001 BBL)*	■	■	■
Crystal Golden Shadow (001 GSHA)	■	■	■
Crystal Luminous Green (001 LUMG)	■	■	■
Crystal Silver Night (001 SINI)	■	■	■
Crystal Silver Shade (001 SSHA)	■	■	■
Crystal Tabac P (001 TAB)*	■	■	■
Jet (280)	■	■	■
Amethyst (204)	■	■	
Aquamarine (202)	■	■	
Light Rose (223)	■	■	
Montana (207)	■	■	

6680 Cosmic Pendant

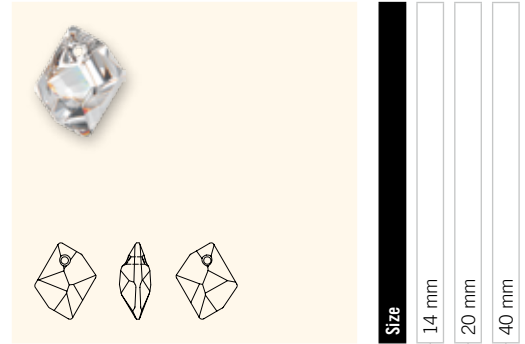

Color	14 mm	20 mm	40 mm
Crystal (001)	■	■	■
Crystal AB (001 AB)	■	■	■
Crystal Antique Pink (001 ANTP)	■	■	■
Crystal Golden Shadow (001 GSHA)	■	■	■
Aquamarine (202)	■	■	
Ruby (501)	■	■	
Violet (371)	■	■	

* For details about the „protective layer“ please refer to page 12.



Pendants

6685 Graphic Pendant

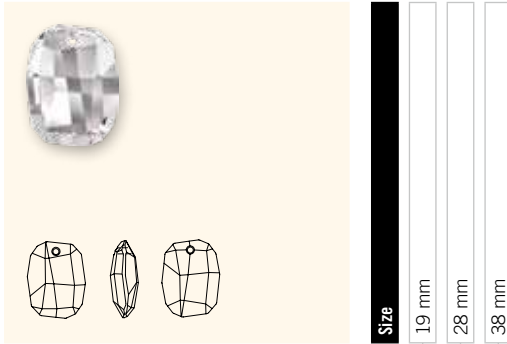

Size
19 mm
28 mm
38 mm

Color		19 mm	28 mm	38 mm
Crystal (001)		■	■	■
Crystal AB (001 AB)		■	■	■
Crystal Astral Pink (001 API)		■	■	■
Crystal Golden Shadow (001 GSHA)		■	■	■
Crystal Red Magma (001 REDM)		■	■	■
Crystal Silver Shade (001 SSHA)		■	■	■
Jet (280)		■	■	■
Amethyst (204)		■	■	
Aquamarine (202)		■	■	
Black Diamond F (215)		■	■	
Denim Blue (266)		■	■	
Emerald (205)		■	■	
Light Amethyst (212)		■	■	
Light Siam (227)		■	■	

6690 Wing Pendant

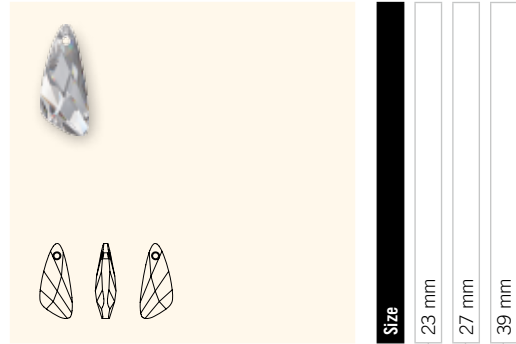

Size
23 mm
27 mm
39 mm

Color		23 mm	27 mm	39 mm
Crystal (001)		■	■	■
Crystal AB (001 AB)		■	■	■
Crystal Antique Pink (001 ANTP)		■	■	■
Crystal Astral Pink (001 API)		■	■	■
Crystal Bronze Shade (001 BRSH)		■	■	■
Crystal Copper (001 COP)		■	■	■
Crystal Golden Shadow (001 GSHA)		■	■	■
Crystal Luminous Green (001 LUMG)		■	■	■
Crystal Red Magma (001 REDM)		■	■	■
Crystal Silver Night (001 SINI)		■	■	■
Crystal Silver Shade (001 SSHA)		■	■	■
Jet (280)		■	■	■
Aquamarine (202)		■		
Capri Blue (243)		■		
Fuchsia (502)		■		
Light Colorado Topaz (246)		■		
Light Rose (223)		■		
Light Topaz (226)		■		
Peridot (214)		■		
Provence Lavender (283)		■	■	
Tanzanite (539)		■		

Pendants

6704 Snowflake Pendant

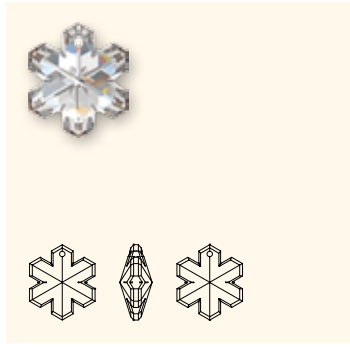

Color	20 mm	25 mm	30 mm
Crystal (001)	■	■	■
Crystal AB (001 AB)	■	■	■
Crystal Blue Shade (001 BLSH)	■	■	■

6714 Star Pendant



Color	20 mm	28 mm	40 mm
Crystal (001)	■	■	■
Crystal AB (001 AB)	■	■	■
Crystal Astral Pink (001 API)	■	■	■
Crystal Blue Shade (001 BLSH)	■	■	■
Jet (280)	■		

6721 Starfish Pendant

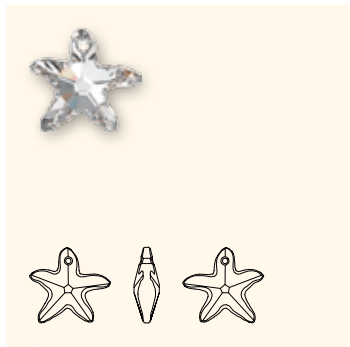

Color	16 mm	20 mm	28 mm	40 mm
Crystal (001)	■	■	■	■
Crystal AB (001 AB)	■	■	■	■
Crystal Antique Pink (001 ANTP)	■	■	■	
Crystal Bermuda Blue P (001 BBL)*	■	■	■	
Crystal Bronze Shade (001 BRSH)	■	■	■	
Crystal Golden Shadow (001 GSHA)	■	■	■	■
Crystal Luminous Green (001 LUMG)	■	■	■	
Crystal Red Magma (001 REDM)	■	■	■	■
Crystal Tabac P (001 TAB)*	■	■	■	
Aquamarine (202)	■	■		
Indicolite (379)	■	■		
Light Amethyst (212)	■	■		
Light Rose (223)	■			
Peridot (214)	■	■		

6722 Moon Pendant

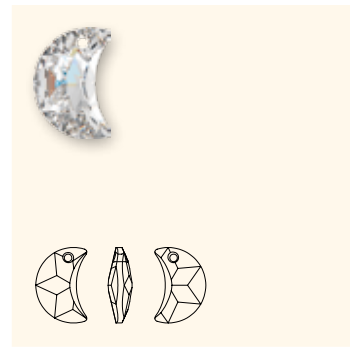

Color	16 mm	20 mm	30 mm
Crystal (001)	■	■	■
Crystal AB (001 AB)	■	■	■

* For details about the „protective layer“ please refer to page 12.

Pendants

6723 Shell Pendant



Size 16 mm
28 mm

Color	
<input type="checkbox"/>	Crystal (001)
<input type="checkbox"/>	Crystal AB (001 AB)
<input type="checkbox"/>	Crystal Golden Shadow (001 GSHA)
<input checked="" type="checkbox"/>	Crystal Red Magma (001 REDM)
<input type="checkbox"/>	Crystal Silver Shade (001 SSHA)
<input type="checkbox"/>	Jet (280)
<input type="checkbox"/>	Aquamarine (202)
<input type="checkbox"/>	Light Rose (223)

6727 Fish Pendant

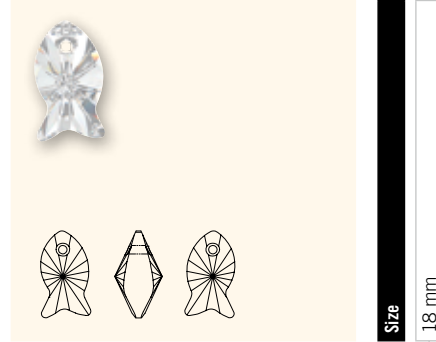

Size 18 mm

Color	
<input type="checkbox"/>	Crystal (001)
<input type="checkbox"/>	Crystal AB (001 AB)
<input type="checkbox"/>	Crystal Golden Shadow (001 GSHA)
<input checked="" type="checkbox"/>	Crystal Red Magma (001 REDM)
<input type="checkbox"/>	Crystal Silver Shade (001 SSHA)
<input type="checkbox"/>	Aquamarine (202)
<input type="checkbox"/>	Capri Blue (243)
<input type="checkbox"/>	Indicolite (379)
<input type="checkbox"/>	Light Rose (223)

6734 Pure Leaf Pendant

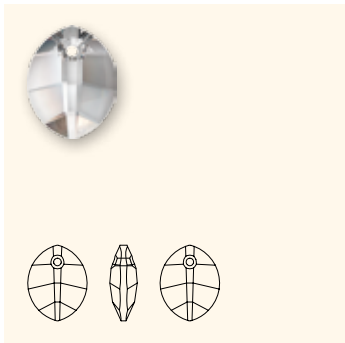

Size 14 mm

6734 Pure Leaf Pendant

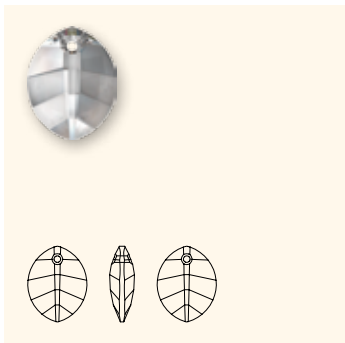

Size 23 mm

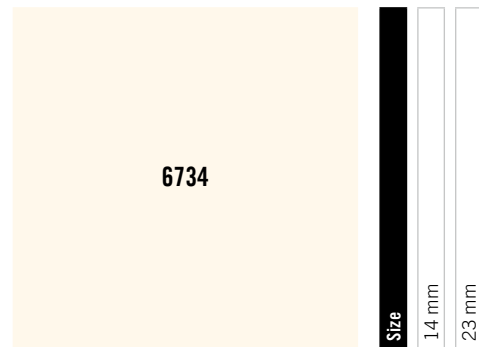

Size 14 mm
23 mm

Color	
<input type="checkbox"/>	Crystal (001)
<input type="checkbox"/>	Crystal AB (001 AB)
<input type="checkbox"/>	Crystal Blue Shade (001 BLSH)
<input type="checkbox"/>	Crystal Golden Shadow (001 GSHA)
<input type="checkbox"/>	Crystal Luminous Green (001 LUMG)
<input checked="" type="checkbox"/>	Crystal Red Magma (001 REDM)
<input type="checkbox"/>	Crystal Silver Night (001 SINI)
<input type="checkbox"/>	Jet (280)
<input type="checkbox"/>	Amethyst (204)
<input type="checkbox"/>	Fern Green (291)
<input type="checkbox"/>	Peridot (214)

Pendants

6735 Leaf Pendant

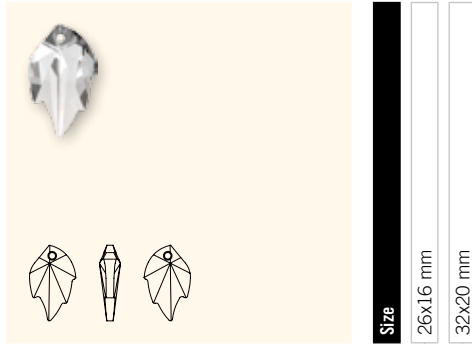

Color		26x16 mm	32x20 mm
	Crystal (001)	<input type="checkbox"/>	<input type="checkbox"/>
	Crystal AB (001 AB)	<input type="checkbox"/>	<input type="checkbox"/>
	Crystal Golden Shadow (001 GSHA)	<input type="checkbox"/>	<input type="checkbox"/>
	Peridot (214)	<input type="checkbox"/>	<input type="checkbox"/>

6744 Flower Pendant

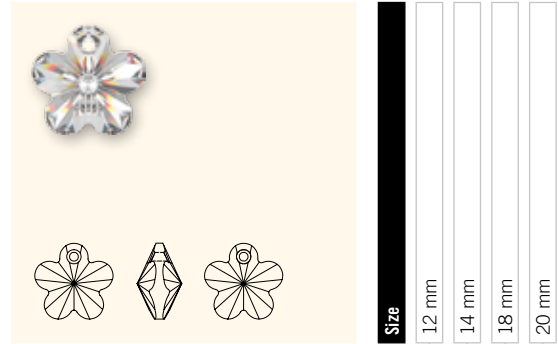

Color		12 mm	14 mm	18 mm	20 mm
	Crystal (001)	<input type="checkbox"/>	<input type="checkbox"/>	<input type="checkbox"/>	<input type="checkbox"/>
	Crystal AB (001 AB)	<input type="checkbox"/>	<input type="checkbox"/>	<input type="checkbox"/>	<input type="checkbox"/>
	Crystal Blue Shade (001 BLSH)	<input type="checkbox"/>	<input type="checkbox"/>	<input type="checkbox"/>	<input type="checkbox"/>
	Crystal Golden Shadow (001 GSHA)	<input type="checkbox"/>	<input type="checkbox"/>	<input type="checkbox"/>	<input type="checkbox"/>
	Jet (280)	<input type="checkbox"/>	<input type="checkbox"/>	<input type="checkbox"/>	<input type="checkbox"/>
	Aquamarine (202)	<input type="checkbox"/>	<input type="checkbox"/>	<input type="checkbox"/>	<input type="checkbox"/>
	Fuchsia (502)	<input type="checkbox"/>	<input type="checkbox"/>	<input type="checkbox"/>	<input type="checkbox"/>
	Light Rose (223)	<input type="checkbox"/>	<input type="checkbox"/>	<input type="checkbox"/>	<input type="checkbox"/>
	Light Siam (227)	<input type="checkbox"/>	<input type="checkbox"/>	<input type="checkbox"/>	<input type="checkbox"/>
	Violet (371)	<input type="checkbox"/>	<input type="checkbox"/>	<input type="checkbox"/>	<input type="checkbox"/>

6754 Butterfly Pendant

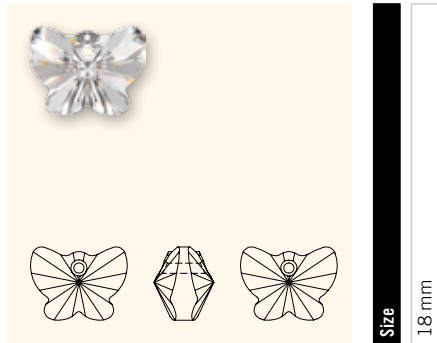

Color		18 mm
	Crystal (001)	<input type="checkbox"/>
	Crystal Astral Pink (001 API)	<input type="checkbox"/>
	Crystal Bronze Shade (001 BRSH)	<input type="checkbox"/>
	Crystal Golden Shadow (001 GSHA)	<input type="checkbox"/>
	Crystal Moonlight (001 MOL)	<input type="checkbox"/>
	Amethyst (204)	<input type="checkbox"/>
	Aquamarine (202)	<input type="checkbox"/>
	Fuchsia (502)	<input type="checkbox"/>
	Light Rose (223)	<input type="checkbox"/>
	Violet (371)	<input type="checkbox"/>
Crystal Blend Color		
	Amethyst Blend (721)	<input type="checkbox"/>
	Topaz Blend (722)	<input type="checkbox"/>

6860

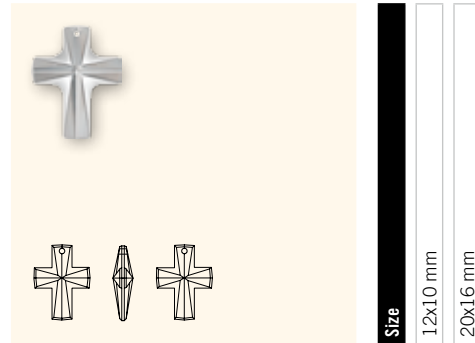

Color		12x10 mm	20x16 mm
	Crystal (001)	<input type="checkbox"/>	<input type="checkbox"/>



Pendants

6864

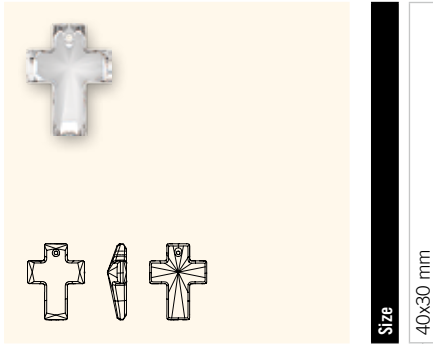

Color

- Crystal (001)
- Crystal AB V (001 AB V)

6866

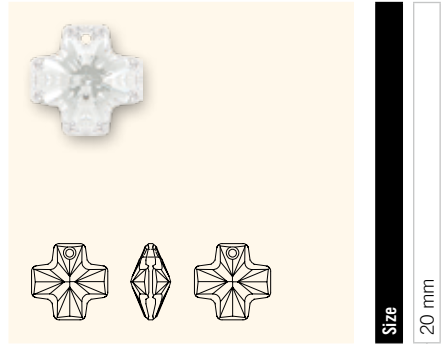

Color

- Crystal (001)
- Crystal AB (001 AB)
- Crystal Astral Pink (001 API)
- Crystal Golden Shadow (001 GSHA)
- Crystal Heliotrope (001 HEL)
- Jet (280)
- Amethyst (204)
- Aquamarine (202)
- Light Rose (223)

6900 Ginko Pendant



Color

- Crystal (001)
- Crystal Golden Shadow (001 GSHA)
- Crystal Satin (001 SAT)
- Crystal Silver Shade (001 SSHA)
- Olivine (228)

6901 Zinnia Pendant



Color

- Crystal (001)
- Crystal Golden Shadow (001 GSHA)
- Crystal Silver Shade (001 SSHA)

Pendants

6902 Zinnia Pendant

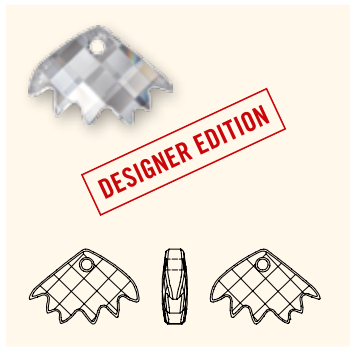

DESIGNER EDITION

Size
16.5x25 mm

Color

- Crystal (001)
- Crystal Golden Shadow (001 GSHA)
- Crystal Silver Shade (001 SSHA)

6904 Lily Pendant



DESIGNER EDITION

Size
30 mm
45 mm

Color

- Crystal (001)
- Crystal Golden Shadow (001 GSHA)
- Crystal Silver Shade (001 SSHA)

6905 Dragonfly Pendant



DESIGNER EDITION

Size
30 mm
45 mm

Color

- Crystal (001)
- Crystal Golden Shadow (001 GSHA)

6906 Orchid Pendant



DESIGNER EDITION

Size
20 mm
40 mm

Color

- Crystal (001)
- Crystal Golden Shadow (001 GSHA)

Pendants

6908 Lotus Pendant



Color	
	Crystal (001)
	Crystal Golden Shadow (001 GSHA)

Size	
	30 mm
	40 mm

6918 Key to Open the Forest

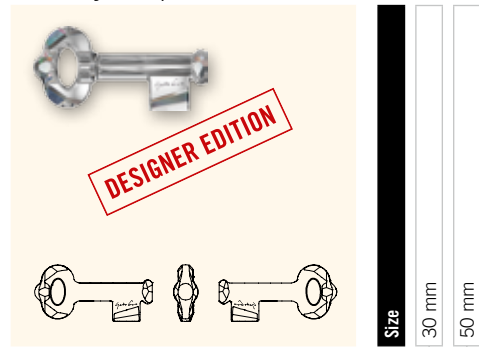

Color	
	Crystal (001)
	Crystal Blue Shade (001 BLSH)
	Crystal Bronze Shade (001 BRSH)
	Crystal Copper (001 COP)
	Crystal Golden Shadow (001 GSHA)*
	Crystal Silver Night (001 SINI)
	Crystal Silver Shade (001 SSHA)
	Indian Sapphire (217)

Size	
	30 mm
	50 mm

6919 Key Pendant

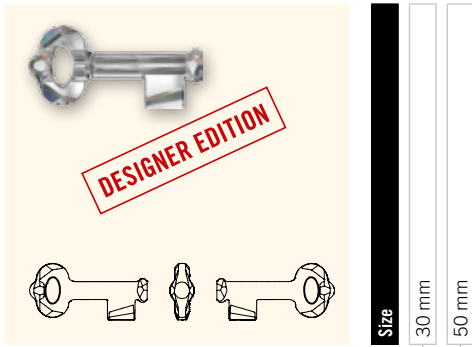

Color	
	Crystal (001)
	Crystal AB (001 AB)
	Crystal Blue Shade (001 BLSH)
	Crystal Bronze Shade (001 BRSH)
	Crystal Copper (001 COP)
	Crystal Golden Shadow (001 GSHA)*
	Crystal Silver Night (001 SINI)
	Crystal Silver Shade (001 SSHA)
	Indian Sapphire (217)

Size	
	30 mm
	50 mm

*Crystal Golden Shadow (001 GSHA) is available as of march 2013.

Article Size	Packing Unit = Minimum Order Quantity in Pieces	Average Net Weight in Gram per Packing Unit Crystal (001)	Average Gross Weight in Gram per Packing Unit Crystal (001)
6000			
11x5.5 mm	288	99.8	123.1
13x6.5 mm	288	156.9	197.5
15x7.5 mm	144	129.8	153.4
22x11 mm	48	129.4	151.3
28x14 mm	24	132.2	156.1
6002			
10x7 mm	144	91.4	109.3
15x11.5 mm	72	175.4	197.3
6007			
7x4 mm	360	46.7	55.8
9x5 mm	288	77.1	104.2
6010			
11x5.5 mm	144	57.4	75.9
13x6.5 mm	144	91.1	109.0
17x8.5 mm	36	57.3	77.2
21x10.5 mm	24	66.3	83.4
50x21.5 mm	6	173.71	222.77
6012			
11x10 mm	144	94.2	120.0
15.4x14 mm	72	126.0	157.3
6015			
13 mm	144	77.6	102.0
17 mm	72	93.2	111.5
21 mm	48	105.9	129.3
50 mm	6	173.7	222.8
6020			
18 mm	36	49.69	72.12
30 mm	12	74.33	95.53
37 mm	6	76.38	82.46
6039			
25 mm	24	88.4	117.5
38 mm	9	92.7	123.8
6040			
20 mm	72	66.29	92.79
30 mm	30	85.37	116.36
40 mm	6	41.68	61.38
6041			
18 mm	30	38.304	63.101
28 mm	12	57.859	80.237
38 mm	6	65.318	88.286
6049			
20 mm	72	170.5	200.4
30 mm	24	166.7	209.2
6090			
16x11 mm	72	55.8	75.8
22x15 mm	48	102.2	136.7
6091			
28 mm	40	157.4	198.9
38 mm	24	229.0	263.7
50 mm	6	115.0	144.2

Pendants

Article Size	Packing Unit = Minimum Order Quantity in Pieces	Average Net Weight in Gram per Packing Unit Crystal (001)	Average Gross Weight in Gram per Packing Unit Crystal (001)
6100			
24x12 mm	36	54.5	83.9
34x20 mm	12	73.0	101.4
6106			
16 mm	144	129.9	158.3
22 mm	96	208.1	248.5
28 mm	36	171.8	201.1
38 mm	9	91.1	121.6
50 mm	6	146.1	177.9
6110			
30x14 mm	36	147.6	178.8
40x18 mm	12	132.6	159.2
6128			
8 mm	144	23.21	34.07
10 mm	288	94.25	122.19
12 mm	144	81.82	101.28
6150			
30 mm	48	140.6	174.5
50 mm	9	109.2	140.7
6191			
19 mm	24	64.3	83.1
27 mm	10	72.8	92.1
48 mm	3	113.2	131.7
6210			
12 mm	144	67.8	90.9
17 mm	72	98.8	122.0
6215			
18 mm	72	183.2	210.5
6225			
10 mm	144	48.3	68.4
18 mm	24	41.6	59.0
28 mm	24	160.7	206.2
6228			
10.3x10 mm	288	124.6	152.6
14.4x14 mm	144	181.4	210.5
18x17.5 mm	72	188.0	211.7
28 mm	16	124.0	158.7
40 mm	6	137.9	169.2
6240			
12 mm	108	63.28	83.47
17 mm	72	116.43	137.02
27 mm	24	142.56	147.84
37 mm	6	80.85	109.25
6260			
17 mm	48	56.25	81.93
27 mm	20	88.72	111.92
37 mm	6	60.26	88.96
6261			
17 mm	48	48.21	76.63
27 mm	20	77.00	102.60
36 mm	12	112.49	135.29

Pendants

Article Size	Packing Unit = Minimum Order Quantity in Pieces	Average Net Weight in Gram per Packing Unit Crystal (001)	Average Gross Weight in Gram per Packing Unit Crystal (001)
6262			
17 mm	48	67.90	91.90
26 mm	16	74.02	92.48
34 mm	6	53.74	80.33
6263			
36 mm	6	79.35	106.95
6264			
18 mm	48	93.41	109.11
28 mm	16	93.74	118.24
36 mm	6	80.35	108.15
6320			
14 mm	96	48.21	70.00
19 mm	48	61.59	78.29
27 mm	24	89.07	101.26
6328			
6 mm	360	78.51	89.50
8 mm	288	153.21	173.20
10 mm	144	144.40	165.00
6401			
8 mm	288	106.8	123.8
12 mm	144	164.9	182.7
14 mm	72	108.7	136.7
6428			
6 mm	720	80.1	89.5
8 mm	144	37.4	46.7
12 mm	144	121.8	141.6
6460			
20 mm	72	60.3	83.1
6470			
32 mm	36	82.47	100.26
40 mm	18	84.07	114.36
48 mm	12	95.69	128.49
6525			
19 mm	72	30.13	61.31
28 mm	36	50.02	81.77
6620			
20 mm	48	88.3	114.6
30 mm	24	126.6	154.8
40 mm	6	81.8	110.5
6621			
18 mm	72	192.8	212.7
28 mm	24	190.8	217.8
6650			
22 mm	24	101.5	119.7
6656			
19 mm	48	72.3	94.2
27 mm	30	126.1	159.6
39 mm	6	61.8	82.0



Pendants

Article Size	Packing Unit = Minimum Order Quantity in Pieces	Average Net Weight in Gram per Packing Unit Crystal (001)	Average Gross Weight in Gram per Packing Unit Crystal (001)
6670			
18 mm	72	68.4	104.6
24 mm	48	105.5	161.9
50 mm	6	104.7	126.8
6680			
14 mm	144	118.7	145.1
20 mm	72	167.5	191.1
40 mm	12	146.3	171.9
6685			
19 mm	48	104.46	127.35
28 mm	24	168.74	175.44
38 mm	6	105.46	121.16
6690			
23 mm	36	54.5	88.6
27 mm	36	99.4	130.5
39 mm	12	95.4	118.7
6704			
20 mm	48	131.4	155.0
25 mm	24	115.8	160.7
30 mm	16	128.1	164.1
6714			
20 mm	48	48.2	73.1
28 mm	24	112.5	156.1
40 mm	6	56.1	87.4
6721			
16 mm	72	105.1	131.7
20 mm	30	76.8	113.6
28 mm	12	66.3	93.7
40 mm	6	83.9	113.5
6722			
16 mm	72	63.9	87.2
20 mm	48	64.3	102.4
30 mm	20	113.8	131.3
6723			
16 mm	96	176.8	215.0
28 mm	18	126.6	160.3
6727			
18 mm	72	168.7	190.1
6734			
14 mm	108	82.555	104.237
23 mm	30	88.452	111.611
6735			
26x16 mm	30	73.3	110.0
32x20 mm	30	136.7	175.6
6744			
12 mm	144	118.7	145.4
14 mm	144	172.9	204.5
18 mm	72	174.8	207.2
20 mm	48	164.7	193.7
6754			
18 mm	72	217.0	248.3

Pendants

Article Size	Packing Unit = Minimum Order Quantity in Pieces	Average Net Weight in Gram per Packing Unit Crystal (001)	Average Gross Weight in Gram per Packing Unit Crystal (001)
6860			
12x10 mm	144	31.2	54.5
20x16 mm	72	48.2	73.1
38x29 mm	24	99.2	134.8
6864			
40x30 mm	9	109.2	142.2
6866			
20 mm	72	249.5	272.8
6900			
13.5x20 mm	72	138.6	170.8
30x45 mm	6	95.9	123.1
6901			
30x45 mm	6	71.3	89.8
6902			
16.5x25 mm	30	85.4	113.1
6904			
30 mm	36	75.3	80.8
45 mm	6	38.2	65.4
6905			
30 mm	30	67.8	97.5
45 mm	6	41.7	68.3
6906			
20 mm	30	57.8	86.5
40 mm	6	75.3	101.8
6908			
30 mm	18	129.6	159.8
40 mm	6	110.5	135.6
6918			
30 mm	36	63.806	88.633
50 mm	6	43.596	66.493
6919			
30 mm	36	63.806	88.633
50 mm	6	43.596	66.493

