

05 BEADS

Beads offer the highest standard available on the market. The high-quality precision cutting and the clear through-hole achieve high brilliance and clarity.

Rounded hole edges reduce the wear on thread and increase the durability of designs. The assortment is divided into classic, romantic, and progressive shape characteristics. They are available in the latest fashion colors, effects, and cuts. BeCharmed Beads with SWAROVSKI ELEMENTS engraving are now available in the Beads assortment. A wide range of colors and effects opens up endless possibilities for different combinations and designs. The main application techniques are beading, wiring, stringing, and weaving. Beads are available as loose crystal elements or as forward-integrated elements.

beads

COLORS & EFFECTS

Colors



Crystal
001



White Opal
234



White Alabaster
281

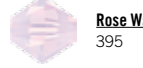

Rose Water Opal
395



Rosaline
508



Vintage Rose
319



Light Rose
223



Rose
209



Indian Pink
289



Fuchsia
502



Ruby
501

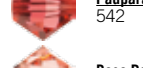

Padparadscha
542



Rose Peach
262



Sun
248



Fireopal
237



Hyacinth
236



Light Siam
227

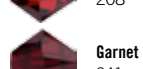

Siam
208

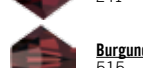

Garnet
241



Burgundy
515



Amethyst
204



Cyclamen Opal
398



Light Amethyst
212



Violet
371

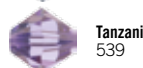

Provence Lavender
283

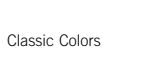

Tanzanite
539

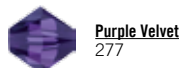

Purple Velvet
277

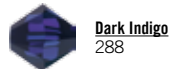

Dark Indigo
288



Montana
207

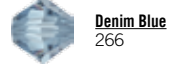

Denim Blue
266

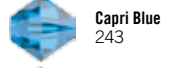

Capri Blue
243



Sapphire
206



Light Sapphire
211

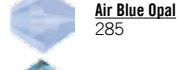

Air Blue Opal
285



Aquamarine
202



Light Azure
361

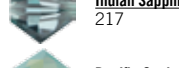

Indian Sapphire
217

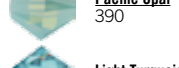

Pacific Opal
390



Light Turquoise
263



Mint Alabaster
397



Turquoise
267



Indicolite
379



Caribbean Blue Opal
394



Blue Zircon
229

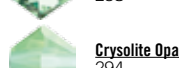

Chrysolite
238



Crysolite Opal
294



Peridot
214

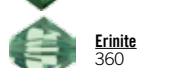

Fern Green
291



Erinite
360



Emerald
205

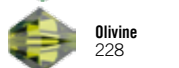

Palace Green Opal
393



Olivine
228

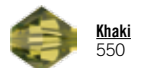

Khaki
550



Sunflower
292



Light Topaz
226



Citrine
249



Jonquil
213



Silk
391



Light Peach
362

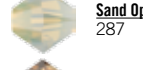

Sand Opal
287



Light Colorado Topaz
246

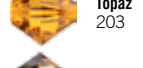

Topaz
203



Light Smoked Topaz
221

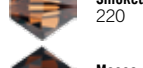

Smoked Topaz
220



Mocca
286



Smoky Quartz
225



Greige
284

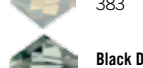

Light Grey Opal
383



Black Diamond
215



Jet
280



Crystal Aurore Boreale
001 AB



Crystal Aurore Boreale 2x
001 AB2



Crystal Satin**
001 SAT



Crystal Comet Argent Light***
001 CAL



Crystal Matt Finish*
001 MAT



Crystal Moonlight
001 MOL



Crystal Silver Shade
001 SSHA



Crystal Luminous Green**
001 LUMG



Crystal Golden Shadow**
001 GSHA



Crystal Copper**
001 COP



Crystal Astral Pink
001 API



Crystal Red Magma**
001 REDM



Crystal Antique Pink
001 ANTP



Crystal Blue Shade**
001 BLSH



Crystal Bermuda Blue**
001 BBL



Crystal Heliotrope**
001 HEL



Crystal Metallic Blue 2x**
001 METBL2



Crystal Vitrail Light**
001 VL



Crystal Vitrail Medium**
001 VM



Crystal Tabac*/**
001 TAB



Crystal Metallic Light Gold 2x**
001 MLG2



Crystal Bronze Shade**
001 BRSH



Crystal Dorado 2x**
001 DOR2



Jet Nut 2x**
280 NUT2



Crystal Silver Night**
001 SINI



Jet Hematite**
280 HEM



Jet Hematite 2x**
280 HEM2

Effects

Crystal Blend Colors



Burgundy-Blue Zircon Blend
001 723



Amethyst Blend
001 721



Fern Green-Topaz Blend
001 724



Topaz Blend
001 722

Numerical Order

001	Crystal	001 722	Topaz Blend	236	Hyacinth	<u>292</u>	<u>Sunflower</u>
001 AB	Crystal Aurore Boreale	001 723	Burgundy-Blue Zircon Blend	<u>237</u>	<u>Fireopal</u>	<u>294</u>	<u>Chrysolite Opal</u>
001 AB2	Crystal Aurore Boreale 2x	001 724	Fern Green-Topaz Blend	238	Chrysolite	<u>319</u>	<u>Vintage Rose</u>
<u>001 ANTP</u>	<u>Crystal Antique Pink</u>	202	Aquamarine	241	Garnet	<u>360</u>	<u>Erinite</u>
<u>001 API</u>	<u>Crystal Astral Pink</u>	203	Topaz	243	Capri Blue	<u>361</u>	<u>Light Azore</u>
001 BBL	Crystal Bermuda Blue**	204	Amethyst	246	Light Colorado Topaz	<u>362</u>	<u>Light Peach</u>
<u>001 BLSH</u>	<u>Crystal Blue Shade**</u>	205	Emerald	248	Sun	371	Violet
<u>001 BRSH</u>	<u>Crystal Bronze Shade**</u>	206	Sapphire	249	Citrine	379	Indicolite
001 CAL	Crystal Comet Argent Light**	207	Montana	<u>262</u>	<u>Rose Peach</u>	<u>383</u>	<u>Light Grey Opal</u>
<u>001 COP</u>	<u>Crystal Copper**</u>	208	Siam	<u>263</u>	<u>Light Turquoise</u>	<u>390</u>	<u>Pacific Opal</u>
<u>001 DOR2</u>	<u>Crystal Dorado 2x**</u>	209	Rose	<u>266</u>	<u>Denim Blue</u>	<u>391</u>	<u>Silk</u>
<u>001 GSHA</u>	<u>Crystal Golden Shadow**</u>	211	Light Sapphire	267	Turquoise	<u>393</u>	<u>Palace Green Opal</u>
001 HEL	Crystal Heliotrope**	212	Light Amethyst	<u>277</u>	<u>Purple Velvet</u>	<u>394</u>	<u>Caribbean Blue Opal</u>
<u>001 LUMG</u>	<u>Crystal Luminous Green**</u>	213	Jonquil	280	Jet	<u>395</u>	<u>Rose Water Opal</u>
001 MAT	Crystal Matt Finish*	214	Peridot	280 HEM	Jet Hematite**	<u>397</u>	<u>Mint Alabaster</u>
<u>001 METBL2</u>	<u>Crystal Metallic Blue 2x**</u>	215	Black Diamond	280 HEM2	Jet Hematite 2x**	<u>398</u>	<u>Cyclamen Opal</u>
<u>001 MLG2</u>	<u>Crystal Metallic Light Gold 2x**</u>	<u>217</u>	<u>Indian Sapphire</u>	<u>280 NUT2</u>	<u>Jet Nut 2x**</u>	501	Ruby
<u>001 MOL</u>	<u>Crystal Moonlight</u>	220	Smoked Topaz	<u>281</u>	<u>White Alabaster</u>	502	Fuchsia
<u>001 REDM</u>	<u>Crystal Red Magma**</u>	<u>221</u>	<u>Light Smoked Topaz</u>	<u>283</u>	<u>Provence Lavender</u>	508	Rosaline
<u>001 SAT</u>	<u>Crystal Satin**</u>	223	Light Rose	<u>284</u>	<u>Greige</u>	<u>515</u>	<u>Burgundy</u>
<u>001 SINI</u>	<u>Crystal Silver Night**</u>	<u>225</u>	<u>Smoky Quartz</u>	<u>285</u>	<u>Air Blue Opal</u>	539	Tanzanite
<u>001 SSHA</u>	<u>Crystal Silver Shade**</u>	<u>226</u>	<u>Light Topaz</u>	<u>286</u>	<u>Mocca</u>	<u>542</u>	<u>Padparadscha</u>
001 TAB	Crystal Tabac*/**	227	Light Siam	<u>287</u>	<u>Sand Opal</u>	<u>550</u>	<u>Khaki</u>
001 VL	Crystal Vitrail Light**	228	Olivine	<u>288</u>	<u>Dark Indigo</u>		
001 VM	Crystal Vitrail Medium	229	Blue Zircon	<u>289</u>	<u>Indian Pink</u>		
001 721	Amethyst Blend	234	White Opal	<u>291</u>	<u>Fern Green</u>		

Alphabetical Order

<u>Air Blue Opal (285)</u>	<u>Crystal Luminous Green** (001 LUMG)</u>	Indicolite (379)	<u>Provence Lavender (283)</u>
Amethyst (204)	Crystal Matt Finish* (001 MAT)	Jet (280)	<u>Purple Velvet (277)</u>
Amethyst Blend (001 721)	<u>Crystal Metallic Blue 2x** (001 METBL2)</u>	Jet Hematite** (280 HEM)	Rosaline (508)
Aquamarine (202)	<u>Crystal Metallic Light Gold 2x** (001 MLG2)</u>	Jet Hematite 2x** (280 HEM2)	Rose (209)
Black Diamond (215)	<u>Crystal Moonlight (001 MOL)</u>	<u>Jet Nut 2x** (280 NUT2)</u>	<u>Rose Peach (262)</u>
Blue Zircon (229)	<u>Crystal Red Magma** (001 REDM)</u>	Jonquil (213)	<u>Rose Water Opal (395)</u>
<u>Burgundy (515)</u>	<u>Crystal Satin** (001 SAT)</u>	<u>Khaki (550)</u>	Ruby (501)
Burgundy-Blue Zircon Blend (001 723)	<u>Crystal Silver Night** (011 SINI)</u>	Light Amethyst (212)	<u>Sand Opal (287)</u>
Capri Blue (243)	<u>Crystal Silver Shade (001 SSHA)</u>	<u>Light Azore (361)</u>	Sapphire (206)
<u>Caribbean Blue Opal (394)</u>	Crystal Tabac*/** (001 TAB)	Light Colorado Topaz (246)	Siam (208)
Citrine (249)	Crystal Vitrail Light** (001 VL)	<u>Light Grey Opal (383)</u>	<u>Silk (391)</u>
Chrysolite (238)	Crystal Vitrail Medium** (001 VM)	<u>Light Peach (362)</u>	Smoked Topaz (220)
Chrysolite Opal (294)	<u>Cyclamen Opal (398)</u>	Light Rose (223)	<u>Smoky Quartz (225)</u>
Crystal (001)	<u>Dark Indigo (288)</u>	Light Sapphire (211)	Sun (248)
Crystal Aurore Boreale (001 AB)	<u>Denim Blue (266)</u>	Light Siam (227)	<u>Sunflower (292)</u>
Crystal Aurore Boreale 2x (001 AB2)	Emerald (205)	<u>Light Smoked Topaz (221)</u>	Tanzanite (539)
<u>Crystal Antique Pink (001 ANTP)</u>	<u>Erinite (360)</u>	<u>Light Topaz (226)</u>	Topaz (203)
<u>Crystal Astral Pink (001 API)</u>	<u>Fern Green (291)</u>	<u>Light Turquoise (263)</u>	Topaz Blend (001 722)
Crystal Bermuda Blue** (001 BBL)	Fern Green-Topaz Blend (001 724)	<u>Mint Alabaster (397)</u>	Turquoise (267)
<u>Crystal Blue Shade** (001 BLSH)</u>	<u>Fireopal (237)</u>	<u>Mocca (286)</u>	<u>Vintage Rose (319)</u>
<u>Crystal Bronze Shade** (001 BRSH)</u>	Fuchsia (502)	Montana (207)	Violet (371)
Crystal Comet Argent Light** (001 CAL)	Garnet (241)	Olivine (228)	<u>White Alabaster (281)</u>
<u>Crystal Copper** (001 COP)</u>	<u>Greige (284)</u>	<u>Pacific Opal (390)</u>	White Opal (234)
<u>Crystal Dorado 2x** (001 DOR2)</u>	Hyacinth (236)	<u>Padparadscha (542)</u>	
<u>Crystal Golden Shadow** (001 GSHA)</u>	<u>Indian Pink (289)</u>	<u>Palace Green Opal (393)</u>	
Crystal Heliotrope** (001 HEL)	<u>Indian Sapphire (217)</u>	Peridot (214)	

Classic Colors: This Color range offers a wide choice of traditional Swarovski crystal Colors.
 Exclusive Colors: This Color range is offered exclusively by Swarovski.

Slight changes in shades are unavoidable.

The plating resistance of effects is tested according to Swarovski's plating guidelines (WWW.SWAROVSKI-ELEMENTS.COM/BUSINESS). Customers are advised to carry out their own tests if customers' plating parameters diverge from Swarovski plating guidelines.

* Colors are only available as special productions.

** Crystals are not resistant to plating and similar processing.

Summary

<<<

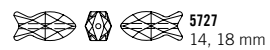
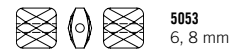
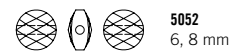
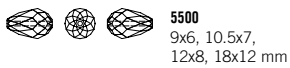
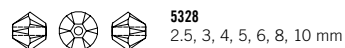
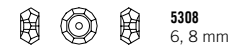
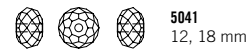
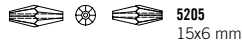
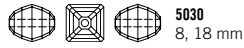
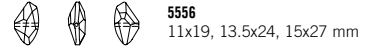
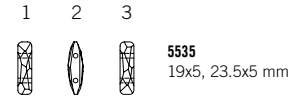
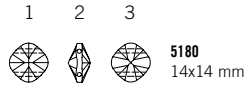
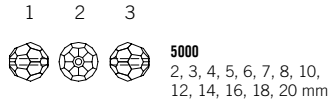

1 Front view 2 Side view 3 Back view

Beads

Beads

05

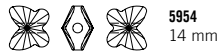
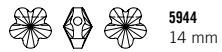
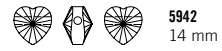
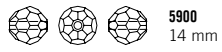
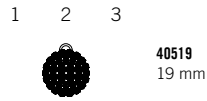

1 Front view 2 Side view 3 Back view





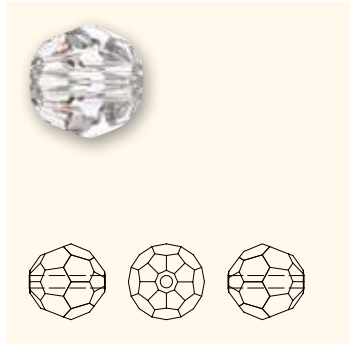

















Beads

5000



Color	2 mm	3 mm	4 mm	5 mm	6 mm	7 mm	8 mm	10 mm	12 mm	14 mm	16 mm	18 mm	20 mm
Crystal (001)	■	■	■	■	■	■	■	■	■	■	■	■	■
Crystal AB (001 AB)	■	■	■	■	■	■	■	■	■	■			
Crystal AB 2x (001 AB2)			■	■	■	■	■	■	■	■			
Crystal Antique Pink (001 ANTP)		■	■	■	■	■	■	■	■	■			
Crystal Blue Shade (001 BLSH)		■	■	■	■	■	■	■	■	■			
Crystal Bronze Shade (001 BRSH)		■	■	■	■	■	■	■	■	■			
Crystal Copper (001 COP)	■	■	■	■	■	■	■	■	■	■			
Crystal Dorado (001 DOR)		■	■	■	■	■	■	■	■	■			
Crystal Dorado 2x (001 DOR2)		■	■	■	■	■	■	■	■	■			
Crystal Golden Shadow (001 GSHA)	■	■	■	■	■	■	■	■	■	■			
Crystal Luminous Green (001 LUMG)		■	■	■	■	■	■	■	■	■			
Crystal Metallic Light Gold 2x (001 MLG2)	■	■	■	■	■	■	■	■	■	■			
Crystal Moonlight (001 MOL)	■	■	■	■	■	■	■	■	■	■			
Crystal Satin (001 SAT)		■	■	■	■	■	■	■	■	■			
Crystal Silver Night (001 SINI)		■	■	■	■	■	■	■	■	■			
Crystal Silver Shade (001 SSHA)	■	■	■	■	■	■	■	■	■	■			
Crystal Vitrail Medium (001 VM)		■	■	■	■	■	■	■	■	■			
Jet (280)	■	■	■	■	■	■	■	■	■	■	■	■	■
Jet AB (280 AB)		■	■	■	■	■	■	■	■	■			
Jet Hematite (280 HEM)		■	■	■	■	■	■	■	■	■			
Jet Hematite 2x (280 HEM2)		■	■	■	■	■	■	■	■	■			
Jet Nut 2x (280 NUT2)		■	■	■	■	■	■	■	■	■			
Amethyst (204)		■	■	■	■	■	■	■	■	■			
Amethyst AB (204 AB)		■	■	■	■	■	■	■	■	■			
Aquamarine (202)		■	■	■	■	■	■	■	■	■			
Aquamarine AB (202 AB)		■	■	■	■	■	■	■	■	■			
Black Diamond (215)		■	■	■	■	■	■	■	■	■			
Black Diamond AB (215 AB)		■	■	■	■	■	■	■	■	■			
Blue Zircon (229)		■	■	■	■	■	■	■	■	■			
Burgundy (515)		■	■	■	■	■	■	■	■	■			
Capri Blue (243)		■	■	■	■	■	■	■	■	■			
Caribbean Blue Opal (394)		■	■	■	■	■	■	■	■	■			
Chrysolite (238)		■	■	■	■	■	■	■	■	■			
Chrysolite Opal (294)		■	■	■	■	■	■	■	■	■			
Cyclamen Opal (398)		■	■	■	■	■	■	■	■	■			
Dark Indigo (288)		■	■	■	■	■	■	■	■	■			
Denim Blue (266)		■	■	■	■	■	■	■	■	■			
Emerald (205)		■	■	■	■	■	■	■	■	■			
Erinite (360)		■	■	■	■	■	■	■	■	■			

Beads

5000		Size														
		2 mm	3 mm	4 mm	5 mm	6 mm	7 mm	8 mm	10 mm	12 mm	14 mm	16 mm	18 mm	20 mm		
Color																
	Rose Peach (262)		■	■		■		■	■							
	Rose Water Opal (395)			■		■		■								
	Ruby (501)			■		■		■								
	Sand Opal (287)			■		■		■								
	Sapphire (206)		■	■		■		■	■							
	Siam (208)		■	■		■		■	■							
	Siam AB (208 AB)			■		■		■								
	Silk (391)			■		■		■								
	Smoked Topaz (220)		■	■		■		■	■							
	Sunflower (292)		■	■		■		■	■							
	Tanzanite (539)		■	■		■		■								
	Tanzanite AB (539 AB)			■		■		■								
	Topaz (203)		■	■		■		■	■							
	Turquoise (267)			■		■		■								
	Vintage Rose (319)		■	■		■		■								
	Violet (371)			■		■		■								
	Violet AB (371 AB)			■		■		■								
	White Alabaster (281)			■		■		■								
	White Opal (234)		■	■		■		■	■							
Crystal Blend Color																
	Amethyst Blend (721)					■		■	■							
	Burgundy-Blue Zircon Blend (723)					■		■	■							
	Fern Green-Topaz Blend (724)					■		■	■							
	Topaz Blend (722)					■		■	■							

Beads

5003

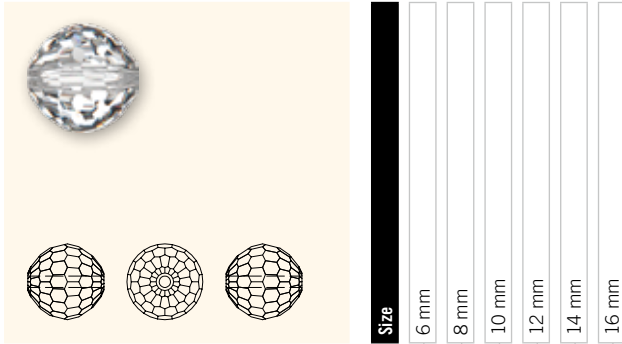

Color

- Crystal (001)
- Crystal AB (001 AB)

- Size**
- 6 mm
 - 8 mm
 - 10 mm
 - 12 mm
 - 14 mm
 - 16 mm

5005 Chessboard Bead

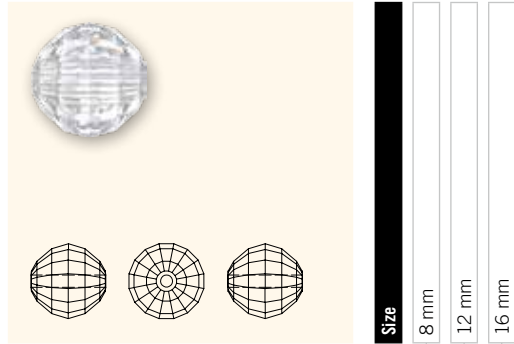

Color

- Crystal (001)
- Crystal AB (001 AB)
- Crystal Golden Shadow (001 GSHA)
- Crystal Silver Shade (001 SSHA)
- Jet (280)

- Size**
- 8 mm
 - 12 mm
 - 16 mm

5020 Helix Bead

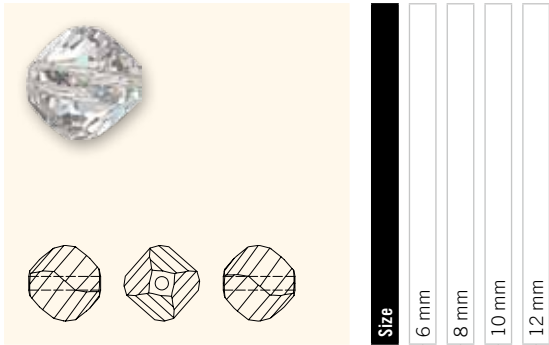

Color

- Crystal (001)
- Crystal AB (001 AB)
- Crystal Golden Shadow (001 GSHA)
- Jet (280)

- Size**
- 6 mm
 - 8 mm
 - 10 mm
 - 12 mm

5030 Lucerna Bead

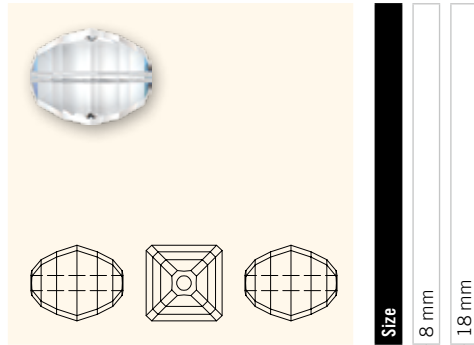

Color

- Crystal (001)
- Crystal AB (001 AB)
- Crystal Copper (001 COP)
- Crystal Golden Shadow (001 GSHA)
- Crystal Silver Shade (001 SSHA)
- Jet (280)
- Amethyst (204)
- Aquamarine (202)
- Black Diamond (215)
- Light Rose (223)
- Light Siam (227)
- Olivine (228)
- Siam (208)

- Size**
- 8 mm
 - 18 mm

Beads

5040 Briolette Bead

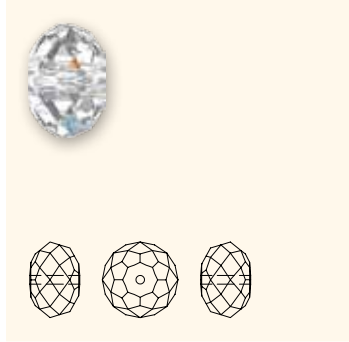

Size	4 mm	6 mm	8 mm	12 mm	18 mm
------	------	------	------	-------	-------

Color	4 mm	6 mm	8 mm	12 mm	18 mm
Crystal (001)	■	■	■	■	■
Crystal AB (001 AB)	■	■	■	■	■
Crystal Antique Pink (001 ANTP)		■	■	■	■
Crystal Astral Pink (001 API)	■	■	■	■	■
Crystal Blue Shade (001 BLSH)	■	■	■	■	■
Crystal Bronze Shade (001 BRSH)	■	■	■	■	
Crystal Copper (001 COP)	■	■	■	■	■
Crystal Golden Shadow (001 GSHA)	■	■	■	■	■
Crystal Luminous Green (001 LUMG)		■	■	■	
Crystal Metallic Light Gold 2x (001 MLG2)		■	■		
Crystal Moonlight (001 MOL)		■	■		
Crystal Red Magma (001 REDM)	■	■	■	■	■
Crystal Silver Night (001 SINI)	■	■	■	■	
Crystal Silver Shade (001 SSHA)	■	■	■	■	■
Jet (280)	■	■	■	■	■
Air Blue Opal (285)		■	■		
Amethyst (204)	■	■	■	■	
Aquamarine (202)		■	■	■	
Black Diamond (215)		■	■	■	
Caribbean Blue Opal (394)		■	■		
Chrysolite Opal (294)		■	■		
Cyclamen Opal (398)		■	■		
Dark Indigo (288)		■	■		
Denim Blue (266)	■	■	■	■	■
Erinite (360)		■	■	■	
Fern Green (291)		■	■		
Greige (284)		■	■	■	
Indian Pink (289)		■	■		
Indicolite (379)		■	■	■	
Jonquil (213)		■	■		
Khaki (550)		■	■	■	
Light Colorado Topaz (246)	■	■	■	■	
Light Rose (223)	■	■	■	■	
Light Siam (227)	■	■	■		
Light Turquoise (263)	■	■	■	■	
Mocca (286)		■	■	■	
Pacific Opal (390)		■	■		
Padparadscha (542)	■	■	■	■	
Peridot (214)		■	■	■	

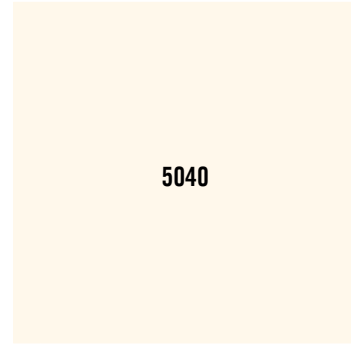

Size	4 mm	6 mm	8 mm	12 mm	18 mm
------	------	------	------	-------	-------

Color	4 mm	6 mm	8 mm	12 mm	18 mm
Provence Lavender (283)		■	■	■	
Purple Velvet (277)		■	■		
Rose Peach (262)		■	■	■	
Siam (208)	■	■	■		
Silk (391)		■	■		
Sunflower (292)		■	■	■	
Tanzanite (539)	■	■	■	■	
Vintage Rose (319)		■	■		
Violet (371)		■	■		
White Opal (234)		■	■	■	
Crystal Blend Color					
Amethyst Blend (721)		■	■	■	
Burgundy-Blue Zircon Blend (723)		■	■	■	
Fern Green-Topaz Blend (724)		■	■	■	
Topaz Blend (722)		■	■	■	

Beads

5041 Briolette Bead (large hole)

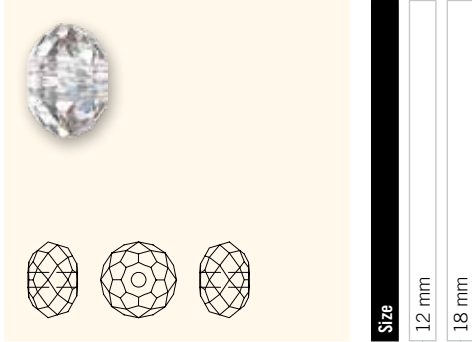

Color		12 mm	18 mm
	Crystal (001)	■	■
	Crystal AB (001 AB)	■	■
	Crystal Astral Pink (001 API)	■	■
	Crystal Golden Shadow (001 GSHA)	■	■
	Crystal Silver Shade (001 SSHA)	■	■
	Jet (280)	■	■

5050 Oval Bead

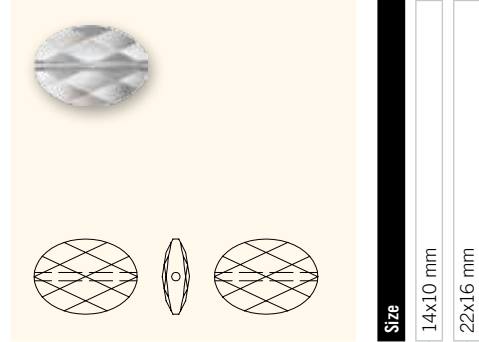

Color		14x10 mm	22x16 mm
	Crystal (001)	■	■
	Crystal AB (001 AB)	■	■
	Crystal Astral Pink (001 API)	■	■
	Crystal Blue Shade (001 BLSH)	■	■
	Crystal Comet Argent Light V P (001 CAL V)*	■	■
	Crystal Golden Shadow (001 GSHA)	■	■
	Crystal Red Magma (001 REDM)	■	■
	Crystal Silver Shade (001 SSHA)	■	■
	Crystal Vitrail Medium P (001 VM)	■	■
	Jet (280)	■	■
	Amethyst (204)	■	■
	Aquamarine (202)	■	■
	Fuchsia (502)	■	■
	Light Amethyst (212)	■	■
	Light Rose (223)	■	■
	Light Topaz (226)	■	■
	Light Turquoise (263)	■	■
	Peridot (214)	■	■
	Topaz (203)	■	■

* For details about the „protective layer“ please refer to page 12.

Beads

5051 Mini Oval Bead

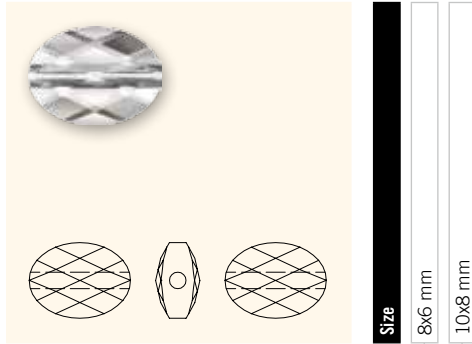

Color		8x6 mm	10x8 mm
Crystal (001)		■	■
Crystal AB (001 AB)		■	■
Crystal Blue Shade (001 BLSH)		■	■
Crystal Bronze Shade (001 BRSH)		■	■
Crystal Golden Shadow (001 GSHA)		■	■
Crystal Red Magma (001 REDM)		■	■
Crystal Silver Shade (001 SSHA)		■	■
Jet (280)		■	■
Amethyst (204)		■	■
Aquamarine (202)		■	■
Black Diamond (215)		■	■
Emerald (205)		■	■
Fern Green (291)		■	■
Indicolite (379)		■	■
Light Turquoise (263)		■	■
Montana (207)		■	■
Siam (208)		■	■
Smoked Topaz (220)		■	■
Sunflower (292)		■	■
Tanzanite (539)		■	■

5052 Mini Round Bead

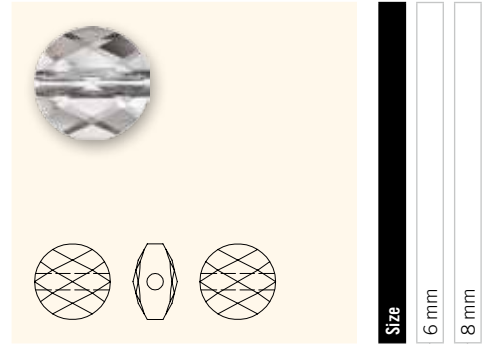

Color		6 mm	8 mm
Crystal (001)		■	■
Crystal AB (001 AB)		■	■
Crystal Blue Shade (001 BLSH)		■	■
Crystal Bronze Shade (001 BRSH)		■	■
Crystal Golden Shadow (001 GSHA)		■	■
Crystal Red Magma (001 REDM)		■	■
Crystal Silver Shade (001 SSHA)		■	■
Jet (280)		■	■
Amethyst (204)		■	■
Aquamarine (202)		■	■
Black Diamond (215)		■	■
Emerald (205)		■	■
Fern Green (291)		■	■
Indicolite (379)		■	■
Light Turquoise (263)		■	■
Montana (207)		■	■
Siam (208)		■	■
Smoked Topaz (220)		■	■
Sunflower (292)		■	■
Tanzanite (539)		■	■

Beads

5053 Mini Square Bead

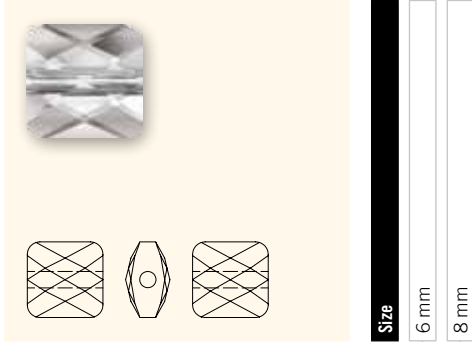

Color	
Crystal (001)	■ ■
Crystal AB (001 AB)	■ ■
Crystal Blue Shade (001 BLSH)	■ ■
Crystal Bronze Shade (001 BRSH)	■ ■
Crystal Golden Shadow (001 GSHA)	■ ■
Crystal Red Magma (001 REDM)	■ ■
Crystal Silver Shade (001 SSHA)	■ ■
Jet (280)	■ ■
Amethyst (204)	■ ■
Aquamarine (202)	■ ■
Black Diamond (215)	■ ■
Emerald (205)	■ ■
Fern Green (291)	■ ■
Indicolite (379)	■ ■
Light Turquoise (263)	■ ■
Montana (207)	■ ■
Siam (208)	■ ■
Smoked Topaz (220)	■ ■
Sunflower (292)	■ ■
Tanzanite (539)	■ ■

5139 Ring Bead

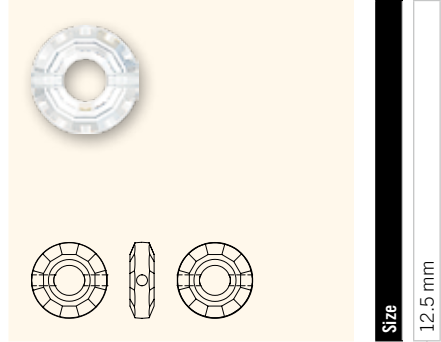

Color	
Crystal (001)	■ ■
Crystal AB (001 AB)	■ ■
Crystal Astral Pink (001 API)	■ ■
Crystal Bronze Shade (001 BRSH)	■ ■
Crystal Golden Shadow (001 GSHA)	■ ■
Crystal Red Magma (001 REDM)	■ ■
Crystal Silver Night (001 SINI)	■ ■
Crystal Silver Shade (001 SSHA)	■ ■
Jet (280)	■ ■
Amethyst (204)	■ ■
Aquamarine (202)	■ ■
Light Topaz (226)	■ ■
Light Turquoise (263)	■ ■
Olivine (228)	■ ■

05 Beads

Beads

5150 Modular Bead

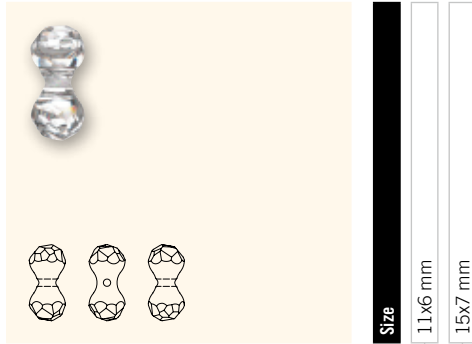

Size	
11x6 mm	15x7 mm

Color	
<input type="checkbox"/>	Crystal (001)
<input type="checkbox"/>	Crystal AB (001 AB)
<input checked="" type="checkbox"/>	Crystal Golden Shadow (001 GSHA)
<input type="checkbox"/>	Jet (280)
<input type="checkbox"/>	Black Diamond (215)

5180 Square Bead (two holes)

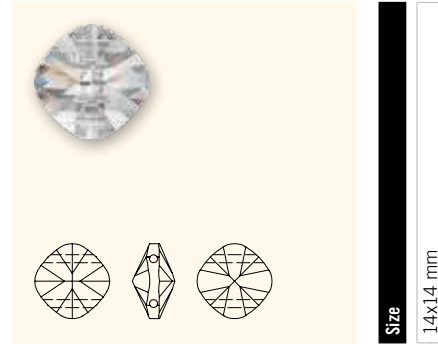

Size	
14x14 mm	

Color	
<input type="checkbox"/>	Crystal (001)
<input type="checkbox"/>	Crystal AB (001 AB)
<input checked="" type="checkbox"/>	Crystal Bronze Shade (001 BRSH)
<input checked="" type="checkbox"/>	Crystal Copper (001 COP)
<input type="checkbox"/>	Crystal Golden Shadow (001 GSHA)
<input checked="" type="checkbox"/>	Crystal Red Magma (001 REDM)
<input checked="" type="checkbox"/>	Crystal Silver Night (001 SINI)
<input checked="" type="checkbox"/>	Crystal Silver Shade (001 SSHA)
<input type="checkbox"/>	Jet (280)
<input type="checkbox"/>	Amethyst (204)
<input type="checkbox"/>	Jonquil (213)
<input type="checkbox"/>	Light Sapphire (211)
<input type="checkbox"/>	Peridot (214)
<input type="checkbox"/>	Rosaline (508)
<input type="checkbox"/>	Sapphire (206)

5181 Keystone Bead (two holes)

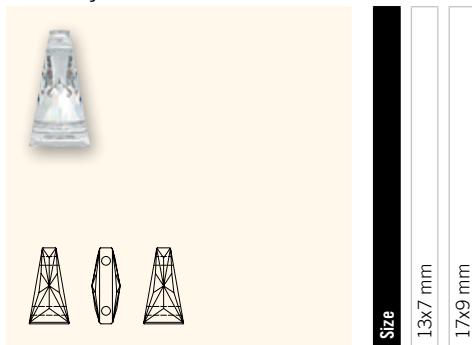

Size	
13x7 mm	17x9 mm

Color	
<input type="checkbox"/>	Crystal (001)
<input type="checkbox"/>	Crystal AB (001 AB)
<input checked="" type="checkbox"/>	Crystal Bronze Shade (001 BRSH)
<input checked="" type="checkbox"/>	Crystal Golden Shadow (001 GSHA)
<input checked="" type="checkbox"/>	Crystal Silver Night (001 SINI)
<input checked="" type="checkbox"/>	Crystal Silver Shade (001 SSHA)
<input type="checkbox"/>	Jet (280)

5200

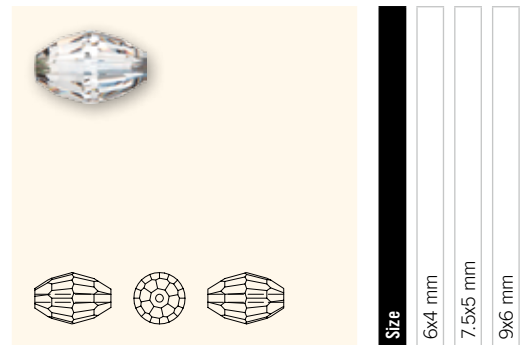

Size		
6x4 mm	7.5x5 mm	9x6 mm

Color	
<input type="checkbox"/>	Crystal (001)
<input type="checkbox"/>	Crystal AB (001 AB)
<input type="checkbox"/>	Jet (280)

Beads

Beads

5203 Polygon Bead

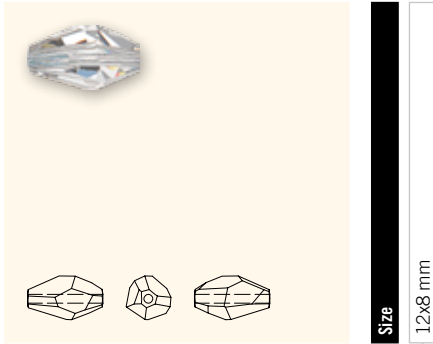

Color	
	Crystal (001)
	Crystal AB (001 AB)
	Crystal Golden Shadow (001 GSHA)
	Jet (280)
	Amethyst (204)
	Light Colorado Topaz (246)
	Olivine (228)
	Padparadscha (542)
	Smoked Topaz (220)

5205

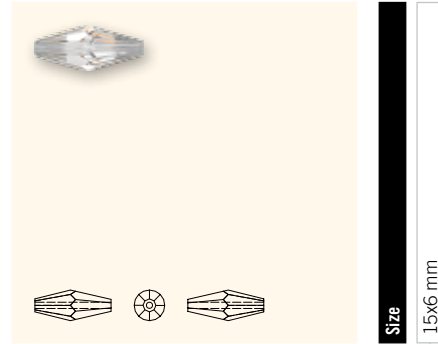

Color	
	Crystal (001)
	Crystal AB (001 AB)

5305

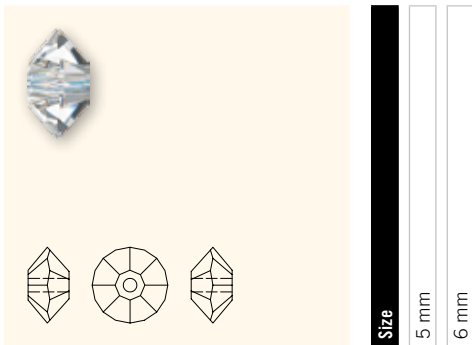

Color	
	Crystal (001)
	Crystal AB (001 AB)
	Jet (280)

5308

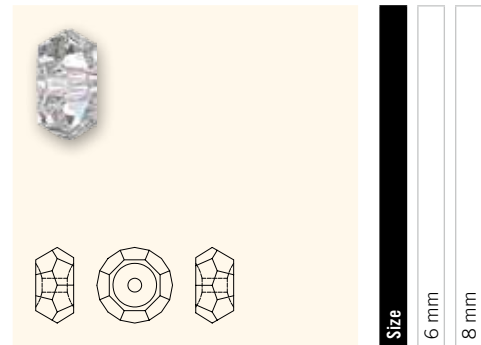

Color	
	Crystal (001)
	Crystal AB (001 AB)

Beads

5328 XILION Bead

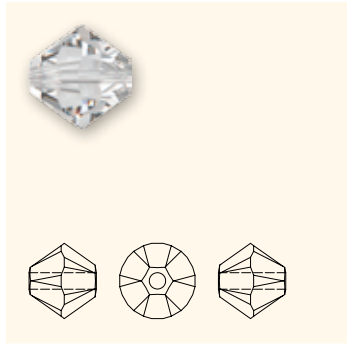

Size	2.5 mm	3 mm	4 mm	5 mm	6 mm	8 mm	10 mm
------	--------	------	------	------	------	------	-------

Color

Crystal (001)	■	■	■	■	■	■	■
Crystal AB (001 AB)	■	■	■	■	■	■	■
Crystal AB 2x (001 AB2)		■	■	■	■		
Crystal AB Satin (001 ABSAT)		■	■	■	■		
Crystal Antique Pink (001 ANTP)		■	■	■	■	■	
Crystal Astral Pink (001 API)		■	■	■	■	■	
Crystal Blue Shade (001 BLSH)		■	■	■	■	■	■
Crystal Bronze Shade (001 BRSH)		■	■	■	■	■	
Crystal Bronze Shade 2x (001 BRSH2)		■	■	■	■	■	
Crystal CAL (001 CAL)		■	■	■	■	■	
Crystal Copper (001 COP)	■	■	■	■	■		
Crystal Dorado 2x (001 DOR2)		■	■	■	■		
Crystal Golden Shadow (001 GSHA)	■	■	■	■	■	■	
Crystal Heliotrope (001 HEL)		■	■				
Crystal Luminous Green (001 LUMG)		■	■	■	■		
Crystal Metallic Blue 2x (001 METBL2)		■	■	■	■		
Crystal Metallic Light Gold 2x (001 MLG2)		■	■	■	■		
Crystal Moonlight (001 MOL)		■	■	■	■		
Crystal Red Magma (001 REDM)		■	■	■	■	■	
Crystal Satin (001 SAT)		■	■	■	■		
Crystal Silver Night (001 SINI)		■	■	■	■	■	
Crystal Silver Shade (001 SSHA)	■	■	■	■	■	■	
Crystal Vitrail Medium (001 VM)		■	■	■	■	■	
Jet (280)	■	■	■	■	■	■	■
Jet AB (280 AB)		■	■	■	■	■	
Jet AB 2x (280 AB2)		■	■	■	■	■	
Jet Hematite (280 HEM)		■	■	■	■	■	
Jet Hematite 2x (280 HEM2)		■	■	■	■	■	
Jet Nut 2x (280 NUT2)		■	■	■	■		
Air Blue Opal (285)		■	■	■	■		
Amethyst (204)		■	■	■	■	■	■
Amethyst AB (204 AB)		■	■	■	■		
Amethyst AB 2x (204 AB2)			■				
Amethyst Satin (204 SAT)			■				
Aquamarine (202)		■	■	■	■	■	■
Aquamarine AB (202 AB)		■	■	■	■	■	
Aquamarine AB 2x (202 AB2)			■				
Aquamarine Satin (202 SAT)			■				
Black Diamond (215)		■	■	■	■	■	



Size	2.5 mm	3 mm	4 mm	5 mm	6 mm	8 mm	10 mm
------	--------	------	------	------	------	------	-------

Color

Black Diamond AB (215 AB)		■	■	■	■		
Black Diamond AB 2x (215 AB2)			■				
Black Diamond Satin (215 SAT)			■				
Blue Zircon (229)		■	■	■	■	■	
Blue Zircon AB (229 AB)			■				
Blue Zircon AB 2x (229 AB2)			■				
Burgundy (515)		■	■	■	■		
Burgundy AB (515 AB)			■				
Capri Blue (243)		■	■	■	■	■	
Capri Blue AB (243 AB)		■	■				
Capri Blue AB 2x (243 AB2)			■				
Capri Blue Satin (243 SAT)			■				
Caribbean Blue Opal (394)		■	■	■	■	■	
Caribbean Blue Opal AB (394 AB)			■				
Chrysolite (238)		■	■	■	■	■	
Chrysolite AB (238 AB)		■	■		■		
Chrysolite AB 2x (238 AB2)			■				
Chrysolite Opal (294)		■	■	■	■	■	■
Chrysolite Satin (238 SAT)			■				
Citrine (249)		■	■	■	■	■	
Citrine AB (249 AB)			■				
Cyclamen Opal (398)		■	■	■	■	■	
Dark Indigo (288)		■	■	■	■	■	
Denim Blue (266)		■	■	■	■	■	■
Emerald (205)		■	■	■	■	■	■
Emerald AB (205 AB)		■	■	■	■		
Emerald AB 2x (205 AB2)			■				
Emerald Satin (205 SAT)			■				
Erinite (360)		■	■	■	■	■	
Erinite AB (360 AB)			■				
Fern Green (291)		■	■	■	■	■	
Fireopal (237)			■	■	■	■	
Fireopal AB (237 AB)			■				
Fireopal AB 2x (237 AB2)			■				
Fuchsia (502)		■	■	■	■	■	
Fuchsia AB (502 AB)		■	■	■	■		
Fuchsia AB 2x (502 AB2)			■				
Fuchsia Satin (502 SAT)			■				
Garnet (241)		■	■	■	■	■	
Garnet AB (241 AB)			■				

Beads

Beads

5328		Size						
		2.5 mm	3 mm	4 mm	5 mm	6 mm	8 mm	10 mm
Color								
	Garnet AB 2x (241 AB2)			■				
	Greige (284)		■	■	■	■	■	
	Hyacinth (236)		■	■	■	■	■	
	Hyacinth AB (236 AB)		■	■				
	Hyacinth AB 2x (236 AB2)			■				
	Hyacinth Satin (236 SAT)			■				
	Indian Pink (289)		■	■	■	■	■	
	Indian Pink AB (289 AB)			■				
	Indian Sapphire (217)		■	■	■	■		
	Indian Sapphire AB (217 AB)			■				
	Indicolite (379)		■	■	■	■	■	
	Indicolite AB (379 AB)			■		■		
	Indicolite AB 2x (379 AB2)			■				
	Indicolite Satin (379 SAT)			■				
	Jonquil (213)		■	■	■	■	■	
	Jonquil AB (213 AB)		■	■	■	■		
	Jonquil AB 2x (213 AB2)			■				
	Jonquil Satin (213 SAT)			■				
	Khaki (550)		■	■	■	■		
	Light Amethyst (212)		■	■	■	■	■	
	Light Amethyst AB (212 AB)		■	■	■	■		
	Light Amethyst AB 2x (212 AB2)			■				
	Light Amethyst Satin (212 SAT)			■				
	Light Azore (361)		■	■	■	■	■	
	Light Azore AB (361 AB)			■		■		
	Light Azore AB 2x (361 AB2)			■				
	Light Azore Satin (361 SAT)			■				
	Light Colorado Topaz (246)		■	■	■	■	■	
	Light Colorado Topaz AB (246 AB)		■	■	■	■	■	
	Light Colorado Topaz AB 2x (246 AB2)			■				
	Light Colorado Topaz Satin (246 SAT)			■				
	Light Grey Opal (383)		■	■	■	■	■	
	Light Peach (362)		■	■	■	■	■	
	Light Peach AB (362 AB)		■	■		■		
	Light Peach AB 2x (362 AB2)			■				
	Light Peach Satin (362 SAT)			■				
	Light Rose (223)		■	■	■	■	■	
	Light Rose AB (223 AB)		■	■	■	■	■	
	Light Rose AB 2x (223 AB2)			■				
	Light Rose Satin (223 SAT)			■				

5328		Size						
		2.5 mm	3 mm	4 mm	5 mm	6 mm	8 mm	10 mm
Color								
	Light Sapphire (211)		■	■	■	■	■	
	Light Sapphire AB (211 AB)		■	■	■	■		
	Light Sapphire AB 2x (211 AB2)			■				
	Light Sapphire Satin (211 SAT)			■				
	Light Siam (227)		■	■	■	■	■	
	Light Siam AB (227 AB)		■	■	■	■		
	Light Siam AB 2x (227 AB2)			■				
	Light Siam Satin (227 SAT)			■				
	Light Smoked Topaz (221)		■	■	■	■		
	Light Smoked Topaz AB (221 AB)			■				
	Light Smoked Topaz AB 2x (221 AB2)			■				
	Light Smoked Topaz Satin (221 SAT)			■				
	Light Topaz (226)		■	■	■	■	■	
	Light Topaz AB (226 AB)			■				
	Light Topaz AB 2x (226 AB2)			■				
	Light Turquoise (263)		■	■	■	■	■	■
	Mint Alabaster (397)		■	■	■	■	■	
	Mint Alabaster AB (397 AB)			■				
	Mint Alabaster AB 2x (397 AB2)			■				
	Mocca (286)		■	■	■	■	■	
	Mocca AB 2x (286 AB2)			■				
	Montana (207)		■	■	■	■	■	
	Montana AB (207 AB)		■	■		■		
	Montana AB 2x (207 AB2)			■				
	Montana Satin (207 SAT)			■				
	Olivine (228)		■	■	■	■	■	
	Olivine AB (228 AB)		■	■	■	■		
	Olivine AB 2x (228 AB2)			■				
	Olivine Satin (228 SAT)			■				
	Pacific Opal (390)		■	■	■	■	■	
	Pacific Opal AB 2x (390 AB2)			■				
	Padparadscha (542)		■	■	■	■	■	
	Padparadscha AB (542 AB)			■		■		
	Padparadscha AB 2x (542 AB2)			■				
	Padparadscha Satin (542 SAT)			■				
	Palace Green Opal (393)		■	■	■	■	■	
	Peridot (214)		■	■	■	■	■	■
	Peridot AB (214 AB)			■		■		
	Peridot AB 2x (214 AB2)			■				
	Peridot Satin (214 SAT)			■				

Beads

5328		Size	2.5 mm	3 mm	4 mm	5 mm	6 mm	8 mm	10 mm
Color									
Provence Lavender (283)			■	■	■	■	■	■	
Purple Velvet (277)			■	■	■	■	■	■	
Purple Velvet AB (277 AB)				■					
Rosaline (508)			■	■	■	■	■	■	
Rosaline AB (508 AB)				■					
Rosaline AB 2x (508 AB2)				■					
Rose (209)			■	■	■	■	■	■	■
Rose AB (209 AB)			■	■	■	■	■	■	
Rose AB 2x (209 AB2)				■					
Rose Peach (262)			■	■	■	■	■	■	■
Rose Satin (209 SAT)				■					
Rose Water Opal (395)			■	■	■	■	■	■	
Rose Water Opal AB (395 AB)				■					
Rose Water Opal AB 2x (395 AB2)				■					
Ruby (501)			■	■	■	■	■	■	
Ruby AB (501 AB)				■		■			
Ruby AB 2x (501 AB2)				■					
Ruby Satin (501 SAT)				■					
Sand Opal (287)			■	■	■	■	■	■	
Sapphire (206)			■	■	■	■	■	■	■
Sapphire AB (206 AB)			■	■	■	■	■		
Sapphire AB 2x (206 AB2)				■					
Sapphire Satin (206 SAT)				■					
Siam (208)			■	■	■	■	■	■	■
Siam AB (208 AB)			■	■	■	■	■		
Siam AB 2x (208 AB2)				■					
Siam Satin (208 SAT)				■					
Silk (391)			■	■	■	■			
Silk AB (391 AB)				■					
Smoked Topaz (220)			■	■	■	■	■		
Smoked Topaz AB (220 AB)				■		■			
Smoked Topaz AB 2x (220 AB2)				■					
Smoky Quartz (225)				■					
Smoky Quartz AB (225 AB)				■					
Smoky Quartz Satin (225 SAT)				■					
Sun (248)			■	■	■	■	■		
Sun AB (248 AB)				■					
Sun AB 2x (248 AB2)				■					
Sunflower (292)			■	■	■	■	■	■	■
Tanzanite (539)			■	■	■	■	■		

5328		Size	2.5 mm	3 mm	4 mm	5 mm	6 mm	8 mm	10 mm
Color									
Tanzanite AB (539 AB)			■	■	■	■			
Tanzanite AB 2x (539 AB2)				■					
Topaz (203)			■	■	■	■	■	■	
Topaz AB (203 AB)			■	■	■	■	■		
Topaz AB 2x (203 AB2)				■					
Topaz Satin (203 SAT)				■					
Turquoise (267)			■	■	■	■			
Turquoise AB (267 AB)			■	■		■			
Turquoise AB 2x (267 AB2)				■					
Vintage Rose (319)			■	■	■	■			
Vintage Rose AB (319 AB)				■					
Violet (371)			■	■	■	■	■	■	
Violet AB (371 AB)			■	■		■			
Violet AB 2x (371 AB2)				■					
White Alabaster (281)			■	■	■	■			
White Alabaster AB 2x (281 AB2)				■					
White Opal (234)			■	■	■	■	■	■	
White Opal AB (234 AB)			■	■		■			
White Opal AB 2x (234 AB2)				■					
Crystal Blend Color									
Amethyst Blend (721)							■	■	■
Burgundy-Blue Zircon Blend (723)					■	■	■		
Fern Green-Topaz Blend (724)					■	■	■		
Topaz Blend (722)							■	■	■

Beads

5500

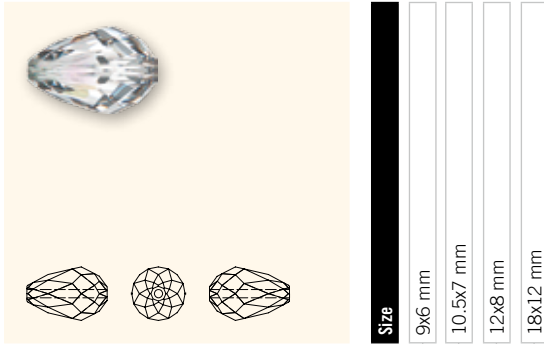

Color		Size			
		9x6 mm	10.5x7 mm	12x8 mm	18x12 mm
Crystal (001)		■	■	■	■
Crystal AB (001 AB)		■	■	■	■
Jet (280)		■			
Amethyst (204)		■			
Aquamarine (202)		■			
Black Diamond (215)		■			
Indicolite (379)		■			
Light Colorado Topaz (246)		■			
Peridot (214)		■			
Rose (209)		■			
Siam (208)		■			
Tanzanite (539)		■			
Topaz (203)		■			
Violet (371)		■			

5520 Graphic Bead

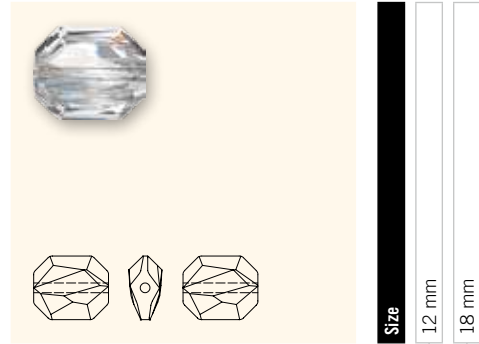

Color		Size	
		12 mm	18 mm
Crystal (001)		■	■
Crystal AB (001 AB)		■	■
Crystal Golden Shadow (001 GSHA)		■	■
Jet (280)		■	■

5523 Cosmic Bead

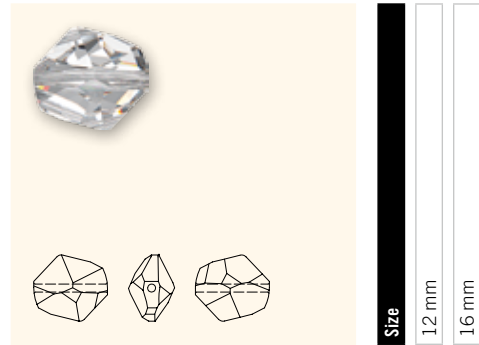

Color		Size	
		12 mm	16 mm
Crystal (001)		■	■
Crystal AB (001 AB)		■	■
Crystal Astral Pink (001 API)		■	■
Crystal Bronze Shade (001 BRSH)		■	■
Crystal Copper (001 COP)		■	■
Crystal Golden Shadow (001 GSHA)		■	■
Crystal Red Magma (001 REDM)		■	■
Crystal Silver Night (001 SINI)		■	■
Crystal Silver Shade (001 SSHA)		■	■
Jet (280)		■	■
Amethyst (204)		■	
Aquamarine (202)		■	
Fuchsia (502)		■	■
Indicolite (379)		■	■
Sunflower (292)		■	■

Beads

5525 Wave Bead

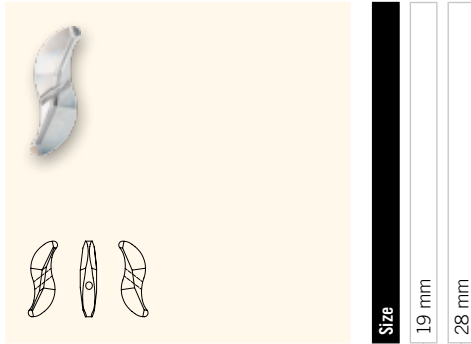

Color		19 mm	28 mm
Crystal (001)		■	■
Crystal AB (001 AB)		■	■
Crystal Antique Pink (001 ANTP)		■	■
Crystal Astral Pink (001 API)		■	■
Crystal Blue Shade (001 BLSH)		■	■
Crystal Golden Shadow (001 GSHA)		■	■
Crystal Luminous Green (001 LUMG)		■	■
Crystal Red Magma (001 REDM)		■	■
Crystal Silver Night (001 SINI)		■	■
Jet (280)		■	■
Amethyst (204)		■	■
Aquamarine (202)		■	■
Denim Blue (266)		■	■

5534 Column Bead (one hole)

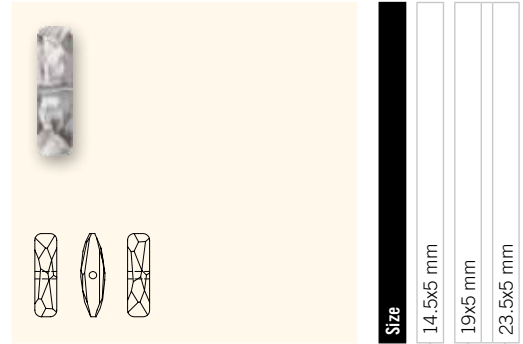

Color		14.5x5 mm	19x5 mm	23.5x5 mm
Crystal (001)		■	■	■
Crystal AB (001 AB)		■	■	■
Crystal Astral Pink (001 API)		■	■	■
Crystal Golden Shadow (001 GSHA)		■	■	■
Crystal Luminous Green (001 LUMG)		■	■	■
Crystal Red Magma (001 REDM)		■	■	■
Crystal Silver Shade (001 SSHA)		■	■	■
Jet (280)		■	■	■

Beads

5535 Column Bead (two holes)

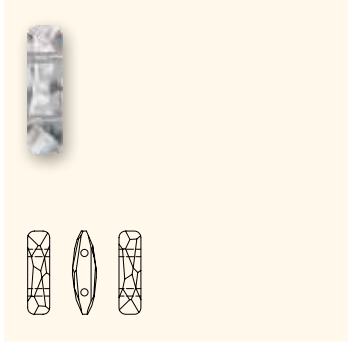

Size	19x5 mm	23.5x5 mm
------	---------	-----------

Color		
Crystal (001)	<input type="checkbox"/>	<input type="checkbox"/>
Crystal AB (001 AB)	<input type="checkbox"/>	<input type="checkbox"/>
Crystal Astral Pink (001 API)	<input type="checkbox"/>	<input type="checkbox"/>
Crystal Golden Shadow (001 GSHA)	<input type="checkbox"/>	<input type="checkbox"/>
Crystal Luminous Green (001 LUMG)	<input type="checkbox"/>	<input type="checkbox"/>
Crystal Red Magma (001 REDM)	<input type="checkbox"/>	<input type="checkbox"/>
Crystal Silver Shade (001 SSHA)	<input type="checkbox"/>	<input type="checkbox"/>
Jet (280)	<input type="checkbox"/>	<input type="checkbox"/>
Amethyst (204)	<input type="checkbox"/>	<input type="checkbox"/>
Aquamarine (202)	<input type="checkbox"/>	<input type="checkbox"/>
Black Diamond (215)	<input type="checkbox"/>	<input type="checkbox"/>
Indicolite (379)	<input type="checkbox"/>	<input type="checkbox"/>
Light Amethyst (212)	<input type="checkbox"/>	<input type="checkbox"/>
Light Colorado Topaz (246)	<input type="checkbox"/>	<input type="checkbox"/>
Light Topaz (226)	<input type="checkbox"/>	<input type="checkbox"/>
Peridot (214)	<input type="checkbox"/>	<input type="checkbox"/>
Provence Lavender (283)	<input type="checkbox"/>	<input type="checkbox"/>
Rosaline (508)	<input type="checkbox"/>	<input type="checkbox"/>
Smoked Topaz (220)	<input type="checkbox"/>	<input type="checkbox"/>

5540 Artemis Bead

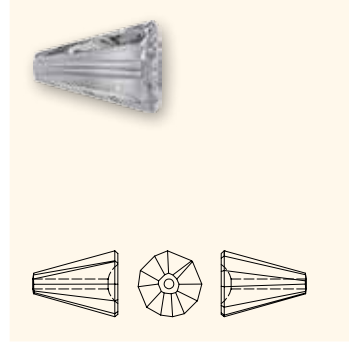

Size	12 mm	17 mm
------	-------	-------

Color		
Crystal (001)	<input type="checkbox"/>	<input type="checkbox"/>
Crystal AB (001 AB)	<input type="checkbox"/>	<input type="checkbox"/>
Crystal Astral Pink (001 API)	<input type="checkbox"/>	<input type="checkbox"/>
Crystal Copper (001 COP)	<input type="checkbox"/>	<input type="checkbox"/>
Crystal Golden Shadow (001 GSHA)	<input type="checkbox"/>	<input type="checkbox"/>
Crystal Red Magma (001 REDM)	<input type="checkbox"/>	<input type="checkbox"/>
Crystal Silver Shade (001 SSHA)	<input type="checkbox"/>	<input type="checkbox"/>
Jet (280)	<input type="checkbox"/>	<input type="checkbox"/>
Amethyst (204)	<input type="checkbox"/>	<input type="checkbox"/>
Aquamarine (202)	<input type="checkbox"/>	<input type="checkbox"/>
Black Diamond (215)	<input type="checkbox"/>	<input type="checkbox"/>
Dark Indigo (288)	<input type="checkbox"/>	<input type="checkbox"/>
Light Amethyst (212)	<input type="checkbox"/>	<input type="checkbox"/>
Light Topaz (226)	<input type="checkbox"/>	<input type="checkbox"/>
Olivine (228)	<input type="checkbox"/>	<input type="checkbox"/>
Smoked Topaz (220)	<input type="checkbox"/>	<input type="checkbox"/>

Beads

5556 Galactic Bead

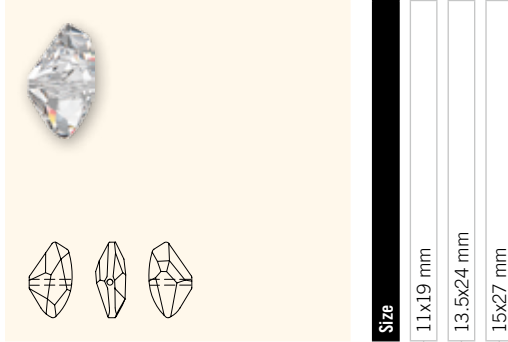

Color	11x19 mm	13.5x24 mm	15x27 mm
Crystal (001)	■	■	■
Crystal Antique Pink (001 ANTP)	■	■	■
Crystal Bermuda Blue P (001 BBL)	■	■	■
Crystal Bronze Shade (001 BRSH)	■	■	■
Crystal Golden Shadow (001 GSHA)	■	■	■
Crystal Red Magma (001 REDM)	■	■	■
Crystal Silver Night (001 SINI)	■	■	■
Crystal Silver Shade (001 SSHA)	■	■	■
Crystal Tabac P (001 TAB)	■	■	■

5590 Wing Bead

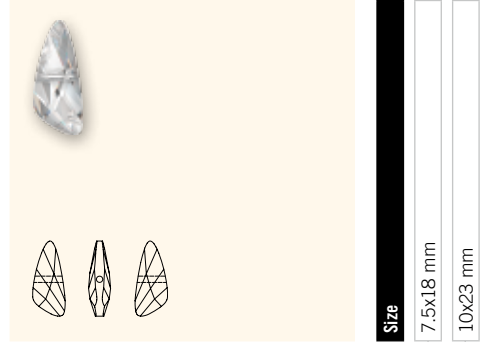

Color	7.5x18 mm	10x23 mm
Crystal (001)	■	■
Crystal AB (001 AB)	■	■
Crystal Bronze Shade (001 BRSH)	■	■
Crystal Copper (001 COP)	■	■
Crystal Golden Shadow (001 GSHA)	■	■
Crystal Red Magma (001 REDM)	■	■
Crystal Silver Night (001 SINI)	■	■
Crystal Silver Shade (001 SSHA)	■	■
Jet (280)	■	■
Aquamarine (202)	■	■
Capri Blue (243)	■	■
Fuchsia (502)	■	■
Light Colorado Topaz (246)	■	■
Light Rose (223)	■	■
Light Topaz (226)	■	■
Peridot (214)	■	■
Provence Lavender (283)	■	■
Tanzanite (539)	■	■

Beads

5601

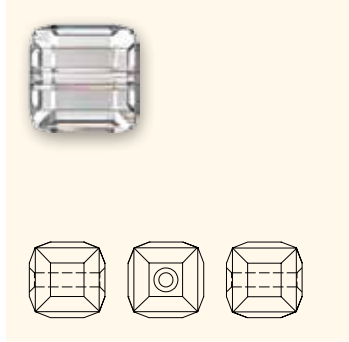

Size	4 mm	6 mm	8 mm	10 mm	12 mm
------	------	------	------	-------	-------

Color	4 mm	6 mm	8 mm	10 mm	12 mm
Crystal (001)	■	■	■	■	■
Crystal AB B (001 ABB)	■	■	■	■	■
Crystal Antique Pink B (001 ANTP)		■	■		
Crystal Blue Shade (001 BLSH)	■	■	■		
Crystal Bronze Shade B (001 BRSH)	■	■	■		
Crystal Bronze Shade B 2x (001 BRSH2)	■	■	■		
Crystal Copper B (001 COPB)	■	■	■		
Crystal Golden Shadow B (001 GSHAB)	■	■	■		
Crystal Luminous Green B (001 LUMGB)	■	■	■		
Crystal Silver Night B (001 SINI)	■	■	■		
Crystal Silver Shade B (001 SSHAB)	■	■	■		
Crystal Vitrail Medium B (001 VMB)	■	■	■		
Jet (280)	■	■	■		
Amethyst (204)	■	■	■		
Aquamarine (202)	■	■	■		
Black Diamond (215)	■	■	■		
Chrysolite Opal (294)	■	■	■		
Denim Blue (266)	■	■	■		
Emerald (205)	■	■	■		
Fern Green (291)	■	■	■		
Fuchsia (502)		■	■		
Light Amethyst (212)		■	■		
Light Colorado Topaz (246)	■	■	■		
Light Rose (223)	■	■	■		
Light Sapphire (211)	■	■	■		
Light Siam (227)		■	■		
Light Topaz (226)		■	■		
Light Turquoise (263)	■	■	■		
Mocca (286)	■	■	■		
Padparadscha (542)		■	■		
Peridot (214)	■	■	■		
Provence Lavender (283)	■	■	■		
Purple Velvet (277)		■	■		
Rose (209)	■	■	■		
Rose Peach (262)	■	■	■		
Sapphire (206)	■	■	■		
Siam (208)	■	■	■		
Sunflower (292)	■	■	■		
Tanzanite (539)	■	■	■		
Topaz (203)	■	■	■		

5603 Graphic Cube Bead



Size	6 mm	8 mm	10 mm
------	------	------	-------

Color	6 mm	8 mm	10 mm
Crystal (001)	■	■	■
Crystal AB (001 AB)	■	■	■
Crystal Golden Shadow (001 GSHA)	■	■	■
Crystal Silver Shade (001 SSHA)	■	■	■

Beads

Beads

5621 Twist Bead

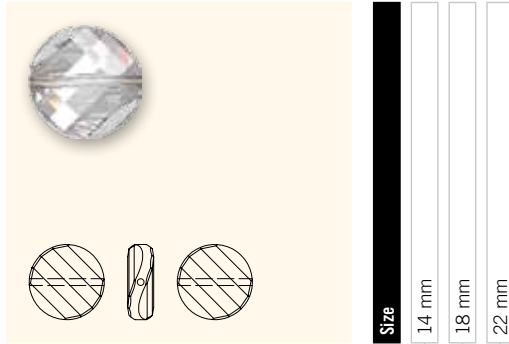

Color	14 mm	18 mm	22 mm
Crystal (001)	■	■	■
Print			
Crystal (001)	■	■	■
Zebra Print			
Print			
Crystal (001)	■	■	■
Paisley Print			
Crystal Astral Pink (001 API)	■	■	■
Crystal Bermuda Blue P (001 BBL)*	■	■	■
Crystal Bronze Shade (001 BRSH)	■	■	■
Crystal Comet Argent Light V P (001 CAL V)*		■	
Crystal Copper (001 COP)	■	■	■
Crystal Golden Shadow (001 GSHA)	■	■	■
Crystal Luminous Green (001 LUMG)	■	■	■
Crystal Moonlight (001 MOL)	■	■	■
Crystal Silver Night (001 SINI)	■	■	■
Crystal Silver Shade (001 SSHA)	■	■	■
Crystal Tabac P (001 TAB)	■	■	■
Crystal Vitrail Medium P (001 VM)		■	
Jet (280)	■	■	■
Amethyst (204)	■	■	
Aquamarine (202)	■	■	
Black Diamond (215)	■	■	
Denim Blue (266)	■	■	■
Jonquil (213)	■	■	
Light Rose (223)	■	■	
Peridot (214)	■	■	
Provence Lavender (283)	■	■	
Sunflower (292)	■	■	

5624 Stairway Bead

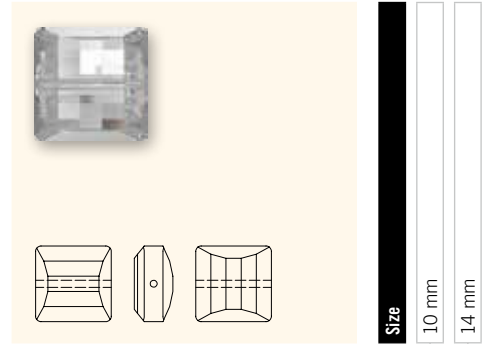

Color	10 mm	14 mm
Crystal (001)	■	■
Crystal AB (001 AB)	■	■
Crystal Antique Pink (001 ANTP)	■	■
Crystal Astral Pink (001 API)	■	■
Crystal Blue Shade (001 BLSH)	■	■
Crystal Copper (001 COP)	■	■
Crystal Golden Shadow (001 GSHA)	■	■
Crystal Red Magma (001 REDM)	■	■
Crystal Silver Shade (001 SSHA)	■	■
Jet (280)	■	■
Amethyst (204)	■	■
Aquamarine (202)	■	■
Denim Blue (266)	■	■
Black Diamond (215)	■	■
Jonquil (213)	■	■
Light Smoked Topaz (221)	■	■
Peridot (214)	■	■
Rosaline (508)	■	■
White Opal (234)	■	■

* For details about the „protective layer“ please refer to page 12.

Beads

5625 Stairway Bead (two holes)

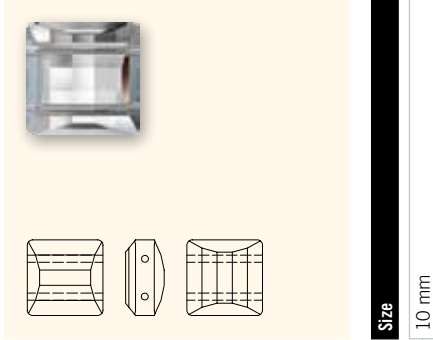

Size
10 mm

Color	
Crystal (001)	■
Crystal AB (001 AB)	■
Crystal Blue Shade (001 BLSH)	■
Crystal Copper (001 COP)	■
Crystal Golden Shadow (001 GSHA)	■
Crystal Red Magma (001 REDM)	■
Crystal Silver Shade (001 SSHA)	■
Jet (280)	■
Amethyst (204)	■
Aquamarine (202)	■
Black Diamond (215)	■
Jonquil (213)	■
Light Smoked Topaz (221)	■
Peridot (214)	■
Rosaline (508)	■
White Opal (234)	■

5650 Cubist Bead

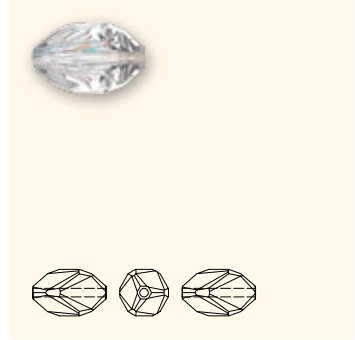

Size
12x8 mm
16x10 mm
20x13.5 mm
28x18.5 mm

Color	
Crystal (001)	■
Crystal AB (001 AB)	■
Crystal Golden Shadow (001 GSHA)	■
Crystal Moonlight (001 MOL)	■
Crystal Silver Shade (001 SSHA)	■
Jet (280)	■
Aquamarine (202)	■
Black Diamond (215)	■
Burgundy (515)	■
Light Amethyst (212)	■
Light Sapphire (211)	■

5714 Star Bead

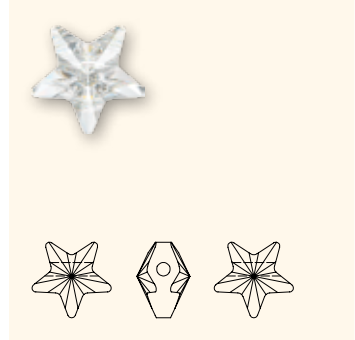

Size
8 mm
12 mm

Color	
Crystal (001)	■
Crystal AB (001 AB)	■
Crystal Golden Shadow (001 GSHA)	■
Crystal Silver Shade (001 SSHA)	■
Jet (280)	■

Beads

5727 Fish Bead

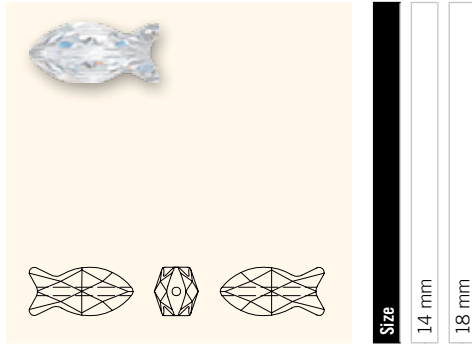

Color		14 mm	18 mm
Crystal (001)		■	■
Crystal AB (001 AB)		■	■
Crystal Antique Pink (001 ANTP)		■	■
Crystal Astral Pink (001 API)		■	■
Crystal Blue Shade (001 BLSH)		■	
Crystal Bronze Shade (001 BRSH)		■	■
Crystal Golden Shadow (001 GSHA)		■	■
Crystal Red Magma (001 REDM)		■	■
Crystal Silver Night (001 SINI)		■	■
Jet (280)		■	
Aquamarine (202)		■	
Capri Blue (243)		■	
Denim Blue (266)		■	
Indicolite (379)		■	
Light Turquoise (263)		■	
Peridot (214)		■	
Sunflower (292)		■	
Topaz (203)		■	
Crystal Blend Color			
Amethyst Blend (721)		■	
Topaz Blend (722)		■	

5742 Heart Bead

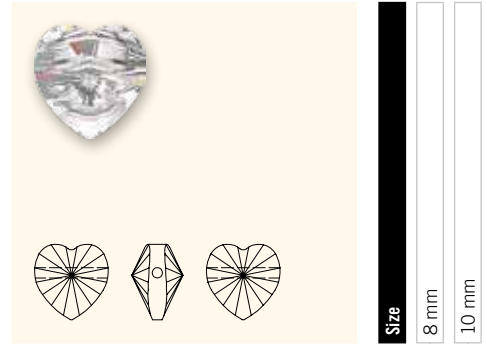

Color		8 mm	10 mm
Crystal (001)		■	■
Crystal AB (001 AB)		■	■
Crystal Astral Pink (001 API)		■	■
Crystal Golden Shadow (001 GSHA)		■	■
Siam (208)		■	■

Beads

5743 Wild Heart Bead

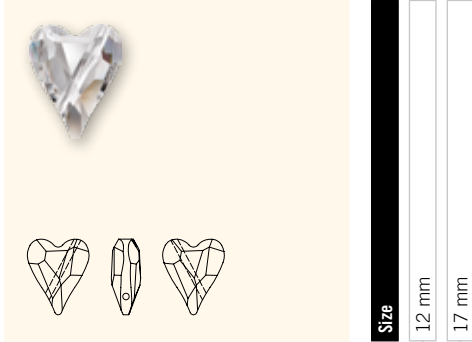

Size
12 mm
17 mm

Color

Crystal (001)	■	■
Crystal AB (001 AB)	■	■
Crystal AB V (001 AB V)	■	■
Crystal Astral Pink (001 API)	■	■
Crystal Astral Pink V (001 API V)	■	■
Crystal Copper (001 COP)	■	■
Crystal Copper V (001 COP V)	■	■
Crystal Golden Shadow (001 GSHA)	■	■
Crystal Golden Shadow V (001 GSHA V)	■	■
Crystal Red Magma (001 REDM)	■	■
Crystal Red Magma V (001 REDM V)	■	■
Crystal Silver Shade (001 SSHA)	■	■
Crystal Silver Shade V (001 SSHA V)	■	■
Jet (280)	■	■
Amethyst (204)	■	■
Aquamarine (202)	■	■
Light Siam (227)	■	■
Light Topaz (226)	■	■
Peridot (214)	■	■
Rosaline (508)	■	■
Rose (209)	■	■
Siam (208)	■	■
Violet (371)	■	■

5744 Flower Bead



Size
6 mm
8 mm

Color

Crystal (001)	■	■
Crystal AB (001 AB)	■	■
Fuchsia (502)	■	■
Light Rose (223)	■	■
Violet (371)	■	■

5752 Clover Bead

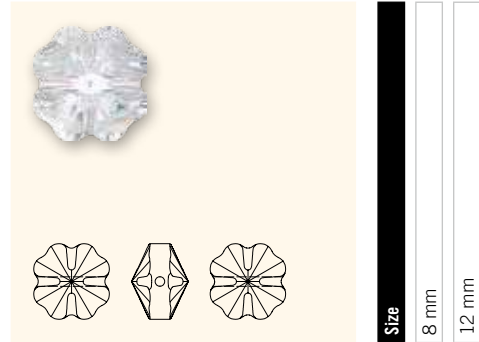

Size
8 mm
12 mm

Color

Crystal (001)	■	■
Crystal AB (001 AB)	■	■
Crystal Copper (001 COP)	■	■
Crystal Golden Shadow (001 GSHA)	■	■
Crystal Red Magma (001 REDM)	■	■
Crystal Silver Shade (001 SSHA)	■	■
Jet (280)	■	■
Aquamarine (202)	■	■
Emerald (205)	■	■
Light Colorado Topaz (246)	■	■
Light Rose (223)	■	■
Light Siam (227)	■	■
Peridot (214)	■	■
Sunflower (292)	■	■

Beads

5754 Butterfly Bead

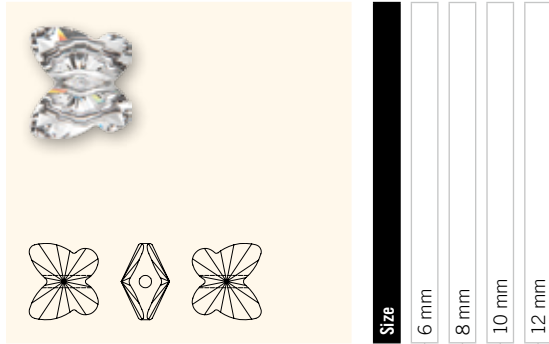

Color	6 mm	8 mm	10 mm	12 mm
Crystal (001)	■	■	■	■
Crystal AB (001 AB)	■	■	■	■
Crystal Antique Pink (001 ANTP)	■	■	■	■
Crystal Astral Pink (001 API)	■	■	■	■
Crystal Bronze Shade (001 BRSH)	■	■	■	■
Crystal Copper (001 COP)	■	■	■	■
Crystal Golden Shadow (001 GSHA)	■	■	■	■
Crystal Metallic Light Gold 2x (001 MLG2)	■	■		
Crystal Silver Night (001 SINI)	■	■	■	■
Crystal Silver Shade (001 SSHA)	■	■	■	■
Jet (280)	■	■	■	
Aquamarine (202)	■	■	■	
Denim Blue (266)	■	■	■	
Fuchsia (502)	■	■	■	
Jonquil (213)	■	■	■	
Light Rose (223)	■	■	■	
Light Siam (227)	■	■	■	
Light Turquoise (263)	■	■	■	
Peridot (214)	■	■	■	
Provence Lavender (283)	■	■	■	
Rose Peach (262)	■	■	■	
Sunflower (292)	■	■	■	
Violet (371)	■	■	■	
Crystal Blend Color				
Amethyst Blend (721)	■	■	■	
Topaz Blend (722)	■	■	■	

5900 (large hole)

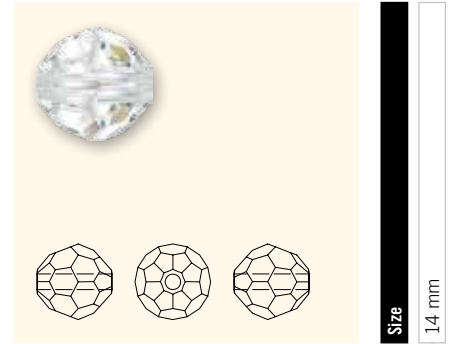

Color	14 mm
Crystal (001)	■
Crystal AB (001 AB)	■
Crystal Blue Shade (001 BLSH)	■
Crystal Bronze Shade (001 BRSH)	■
Crystal Golden Shadow (001 GSHA)	■
Crystal Red Magma (001 REDM)	■
Crystal Silver Shade (001 SSHA)	■
Jet (280)	■

5914 Star Bead (large hole)

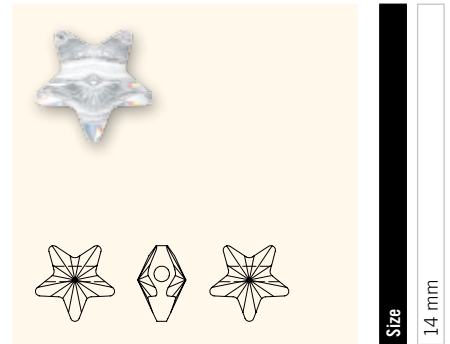

Color	14 mm
Crystal (001)	■
Crystal AB (001 AB)	■
Crystal Bronze Shade (001 BRSH)	■
Crystal Golden Shadow (001 GSHA)	■
Crystal Red Magma (001 REDM)	■
Crystal Silver Shade (001 SSHA)	■
Jet (280)	■

Beads

5928 BeCharmed Helix Bead

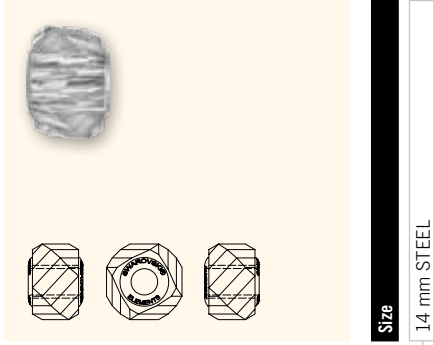

Size
14 mm STEEL

Color

- Crystal (001)
- Crystal AB (001 AB)
- Crystal Astral Pink (001 API)
- Crystal Blue Shade (001 BLSH)
- Crystal Bronze Shade (001 BRSH)
- Crystal Copper (001 COP)
- Crystal Golden Shadow (001 GSHA)
- Crystal Red Magma (001 REDM)
- Crystal Satin (001 SAT)
- Crystal Silver Shade (001 SSHA)
- Jet (280)

- Amethyst (204)
- Aquamarine (202)
- Chrysolite (238)
- Emerald (205)
- Fern Green (291)
- Fuchsia (502)
- Indian Sapphire (217)
- Indicolite (379)
- Jonquil (213)
- Light Amethyst (212)
- Light Rose (223)
- Light Sapphire (211)
- Light Smoked Topaz (221)
- Light Topaz (226)
- Mocca (286)
- Montana (207)
- Olivine (228)
- Peridot (214)
- Rosaline (508)
- Rose (209)
- Sapphire (206)
- Smoked Topaz (220)
- Topaz (203)
- Violet (371)
- White Opal (234)

5942 Heart Bead (large hole)

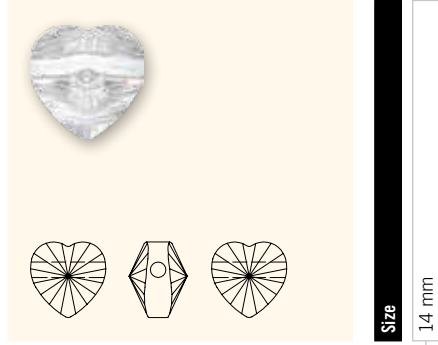

Size
14 mm

Color

- Crystal (001)
- Crystal AB (001 AB)
- Crystal Bronze Shade (001 BRSH)
- Crystal Golden Shadow (001 GSHA)
- Crystal Red Magma (001 REDM)
- Crystal Silver Shade (001 SSHA)
- Jet (280)

5944 Flower Bead (large hole)

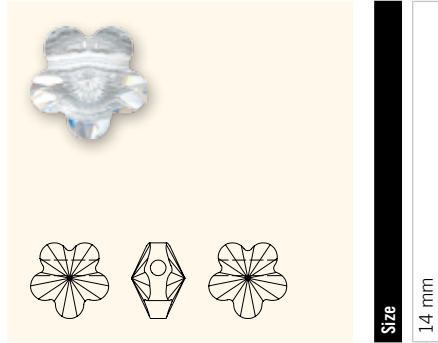

Size
14 mm

Color

- Crystal (001)
- Crystal AB (001 AB)
- Crystal Bronze Shade (001 BRSH)
- Crystal Golden Shadow (001 GSHA)
- Crystal Red Magma (001 REDM)
- Crystal Silver Shade (001 SSHA)
- Jet (280)

Beads

5948 BeCharmed Briolette Bead

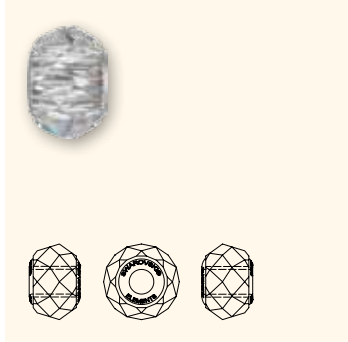

Size
14 mm STEEL

Color

- Crystal (001)
- Crystal AB (001 AB)
- Crystal Astral Pink (001 API)
- Crystal Blue Shade (001 BLSH)
- Crystal Bronze Shade (001 BRSH)
- Crystal Copper (001 COP)
- Crystal Golden Shadow (001 GSHA)
- Crystal Red Magma (001 REDM)
- Crystal Satin (001 SAT)
- Crystal Silver Shade (001 SSHA)
- Jet (280)

- Amethyst (204)
- Aquamarine (202)
- Chrysolite (238)
- Emerald (205)
- Fern Green (291)
- Fuchsia (502)
- Indian Sapphire (217)
- Indicolite (379)
- Jonquil (213)
- Light Amethyst (212)
- Light Rose (223)
- Light Sapphire (211)
- Light Smoked Topaz (221)
- Light Topaz (226)
- Mocca (286)
- Montana (207)
- Olivine (228)
- Peridot (214)
- Rosaline (508)
- Rose (209)
- Sapphire (206)
- Smoked Topaz (220)
- Topaz (203)
- Violet (371)
- White Opal (234)

5954 Butterfly Bead (large hole)

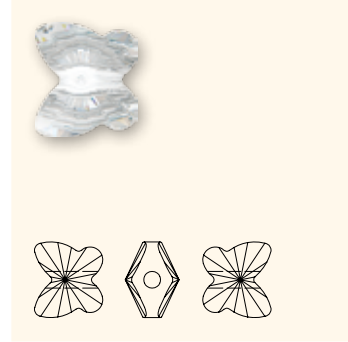

Size
14 mm

Color

- Crystal (001)
- Crystal AB (001 AB)
- Crystal Bronze Shade (001 BRSH)
- Crystal Golden Shadow (001 GSHA)
- Crystal Red Magma (001 REDM)
- Crystal Silver Shade (001 SSHA)
- Jet (280)

Article Explanation

40 512 Crystal Mesh Ball



S	12 mm	
M	12 PCS	100%

40 512	S	M	100%
Article Number	Size	Minimum Order Quantity in pieces (PCS)	Documentation size in %

Explanation “Color Combinations”

All mentioned color combinations are preestablished in terms of

- Crystal color
- Crystal Pearl color
- Casing color

and not modifiable. Within the available combinations you can choose from two different ring configurations.

Ordering Example & Product Variety Explanation

40 512	082	001	001 650	0
Article number	Color of casing	Color of crystals	Color of Crystal Pearl	Ring configuration
		Please see the respective product matrix for available code reference	Please see the respective product matrix for available code reference	0 no jump ring 1 with 1 jump ring

Available Crystal Mesh Balls Colors

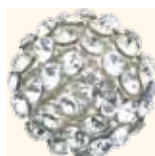

Crystal F (001)



Crystal Aurore Boreale F (001 AB)



Crystal Golden Shadow F (001 GSHA)



Crystal Red Magma F (001 REDM)



Crystal Silver Night (001 SINI)

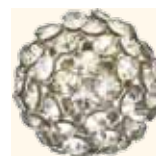

Crystal Silver Shade F (001 SSFA)



Jet (280)



Jet Hematite (280 HEM)

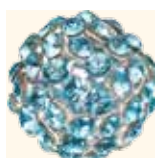

Aquamarine F (202)

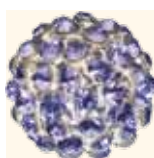

Tanzanite F (539)



Vintage Rose F (319)

Beads

40 512 Crystal Mesh Ball



S	12 mm	
M	12 PCS	100%

40 515 Crystal Mesh Ball



S	15 mm	
M	12 PCS	100%

40 519 Crystal Mesh Ball

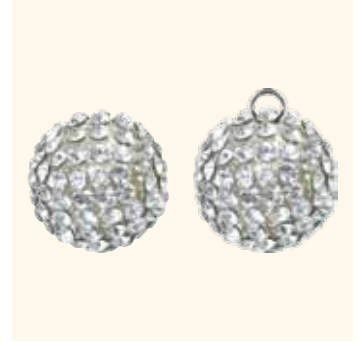

S	19 mm	
M	6 PCS	100%

40 512
40 515
40 519

Ring Configuration

0 no jump ring*

1 with 1 jump ring**

Color Combinations

<ul style="list-style-type: none"> Crystal F (001) Crystal White Pearl (001 650) Casing Color: 082 Silver 	■ ■
<ul style="list-style-type: none"> Crystal AB F (001 AB) Crystal White Pearl (001 650) Casing Color: 082 Silver 	■ ■
<ul style="list-style-type: none"> Crystal Golden Shadow F (001 GSHA) Crystal Vintage Gold Pearl (001 651) Casing Color: 082 Silver 	■ ■
<ul style="list-style-type: none"> Crystal Red Magma F (001 REDM) Crystal Copper Pearl (001 159) Casing Color: 081 Gold 	■ ■
<ul style="list-style-type: none"> Crystal Silver Night F (001 SINI) Crystal Dark Grey Pearl (001 617) Casing Color: 082 Silver 	■ ■
<ul style="list-style-type: none"> Crystal Silver Shade F (001 SSHA) Crystal Platinum Pearl (001 459) Casing Color: 082 Silver 	■ ■
<ul style="list-style-type: none"> Jet (280) Crystal Mystic Black Pearl (001 335) Casing Color: 012 Black 	■ ■
<ul style="list-style-type: none"> Jet Hematite (280 HEM) Crystal Black Pearl (001 298) Casing Color: 012 Black 	■ ■
<ul style="list-style-type: none"> Aquamarine F (202) Crystal Light Blue Pearl (001 302) Casing Color: 082 Silver 	■ ■
<ul style="list-style-type: none"> Tanzanite F (539) Crystal Mauve Pearl (001 160) Casing Color: 082 Silver 	■ ■
<ul style="list-style-type: none"> Vintage Rose F (319) Crystal Rosaline Pearl (001 294) Casing Color: 082 Silver 	■ ■

* The used thread enables a comfortable identification of the hole position and is not meant to be used for further application.

** The color of the jump ring is preestablished and can be seen in the article number. On special request the Crystal Mesh Ball can also be supplied with 2 jump rings.

Complementary Products

<<<

These protective plastic spacer rings are recommended for the use in between Beads, as they facilitate the longevity of the designs and enable the utilisation of larger sized Beads and complex cuts. Please order art. 7800 Nr. 646 with Sys.no. 977980 (packing unit = 100 pcs) and art. 7800 Nr. 647 with Sys.no. 977981 (packing unit = 1,000 pcs).

7800 Protective Spacer Rings

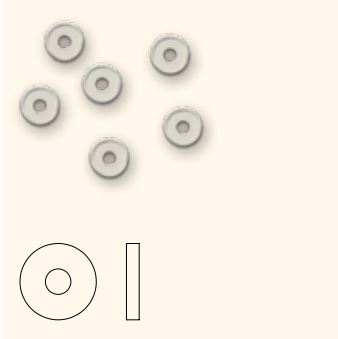

C	Transparent	
S	3 mm (hole 1 mm)	
M	100 PCS (Nr. 646)	
	1,000 PCS (Nr. 647)	150%

Product Details

<<<

Article Size	Packing Unit = Minimum Order Quantity in Pieces	Average Net Weight in Gram per Packing Unit Crystal (001)	Average Gross Weight in Gram per Packing Unit Crystal (001)
5000			
2 mm	1,440	11.5	20.8
3 mm	720	23.6	33.4
4 mm	720	53.5	62.6
5 mm	720	105.3	116.3
6 mm	360	81.6	92.5
7 mm	288	126.2	159.2
8 mm	288	193.5	200.8
10 mm	144	180.6	199.4
12 mm	72	144.2	166.1
14 mm	72	247.1	280.5
16 mm	48	252.3	296.6
18 mm	24	168.7	185.9
20 mm	12	123.5	142.9
5003			
6 mm	360	109.9	120.8
8 mm	144	100.4	118.6
10 mm	144	195.9	219.2
12 mm	72	158.5	179.2
14 mm	48	172.4	193.0
16 mm	48	269.2	289.5
5005			
8 mm	216	145.4	172.1
12 mm	72	154.3	175.4
16 mm	24	122.1	146.7
5020			
4 mm	720	45.4	54.5
6 mm	360	74.5	85.2
8 mm	288	146.6	178.2
10 mm	144	116.4	139.2
12 mm	144	229.0	262.1
5030			
8 mm	144	62.11	93.75
18 mm	24	120.53	122.14
5040			
4 mm	720	41.3	50.4
6 mm	360	71.8	82.9
8 mm	288	135.6	163.7
12 mm	144	214.4	242.4
18 mm	24	121.4	140.2
5041			
12 mm	144	204.9	248.1
18 mm	24	114.2	133.0
5050			
14x10 mm	72	66.29	86.67
22x16 mm	36	90.40	115.60
5051			
8x6 mm	288	67.249	76.379
10x8 mm	144	50.803	74.903
5052			
6 mm	288	49.728	48.859
8 mm	144	42.336	65.831

Beads

Article Size	Packing Unit = Minimum Order Quantity in Pieces	Average Net Weight in Gram per Packing Unit Crystal (001)	Average Gross Weight in Gram per Packing Unit Crystal (001)
5053			
6 mm	288	49.728	58.859
8 mm	144	54.432	71.820
5139			
12.5 mm	48	44.6	61.8
5150			
11x6 mm	216	100.2	125.6
15x7 mm	72	66.3	84.5
5180			
14x14 mm	144	232.6	256.0
5181			
13x7 mm	144	72.3	94.6
17x9 mm	48	52.2	72.2
5200			
6x4 mm	360	44.1	53.2
7.5x5 mm	360	80.0	91.0
9x6 mm	144	56.7	67.6
5203			
12x8 mm	144	82.7	106.2
5205			
15x6 mm	144	71.4	90.1
5305			
5 mm	720	52.7	63.9
6 mm	360	50.5	61.4
5308			
6 mm	360	54.4	65.4
8 mm	288	91.6	118.1
5328			
2.5 mm	1,440	23.8	31.4
3 mm	1,440	34.1	45.2
4 mm	1,440	81.8	89.2
5 mm	720	89.3	100.0
6 mm	360	73.7	84.6
8 mm	288	141.8	173.4
10 mm	144	140.4	154.0
5500			
9x6 mm	144	59.0	69.9.0
10.5x7 mm	144	88.8	109.6
12x8 mm	144	144.0	164.1
18x12 mm	72	211.3	241.4
5520			
12 mm	144	154.4	178.9
18 mm	72	250.1	280.2
5523			
12 mm	144	143.2	173.6
16 mm	72	156.1	194.7
5525			
19 mm	72	30.13	58.14
28 mm	36	48.21	83.92

Beads

Article Size	Packing Unit = Minimum Order Quantity in Pieces	Average Net Weight in Gram per Packing Unit Crystal (001)	Average Gross Weight in Gram per Packing Unit Crystal (001)
5534			
14.5x5 mm	108	76.02	92.55
19x5 mm	72	57.25	86.12
23.5x5 mm	48	53.96	78.68
5535			
19x5 mm	72	60.26	85.54
23.5x5 mm	48	54.48	79.29
5540			
12 mm	72	62.1	86.7
17 mm	48	108.9	133.5
5556			
11x19 mm	96	154.3	189.8
13.5x24 mm	36	111.5	135.0
15x27 mm	30	128.1	160.4
5590			
7.5x18 mm	108	85.9	134.3
10x23 mm	36	60.6	98.4
5600			
4 mm	288	44.2	65.4
6 mm	144	79.0	100.3
8 mm	144	192.1	211.3
5601			
4 mm	288	43.9	65.2
6 mm	144	70.6	88.9
8 mm	96	100.2	118.4
10 mm	72	138.0	156.5
12 mm	36	129.6	147.7
5603			
4 mm	288	34.7	58.6
6 mm	288	117.8	142.4
8 mm	144	119.3	138.6
10 mm	96	179.1	205.9
5621			
14 mm	96	168.7	202.1
18 mm	72	253.1	283.8
22 mm	24	142.6	159.8
5624			
10 mm	108	117.51	134.15
14 mm	72	174.77	204.50
5625			
10 mm	108	108.86	127.0
5650			
12x8 mm	144	108.1	131.9
16x10 mm	72	138.0	153.9
20x13.5 mm	48	140.6	167.3
28x18.5 mm	12	97.4	123.6
5714			
8 mm	288	73.3	102.1
12 mm	108	72.3	102.2

Beads

Article Size	Packing Unit = Minimum Order Quantity in Pieces	Average Net Weight in Gram per Packing Unit Crystal (001)	Average Gross Weight in Gram per Packing Unit Crystal (001)
5727			
14 mm	108	72.3	105.4
18 mm	72	114.5	138.2
5742			
8 mm	288	120.5	154.5
10 mm	288	233.1	266.5
14 mm	96	178.4	219.2
5743			
12 mm	108	72.23	96.96
17 mm	72	122.58	134.82
5744			
6 mm	360	47.4	58.1
8 mm	288	80.2	112.3
5752			
8 mm	288	106.06	136.88
12 mm	96	117.74	137.49
5754			
6 mm	360	42.3	53.0
8 mm	288	77.9	109.8
10 mm	288	156.9	188.9
12 mm	144	136.7	168.9
5900			
14 mm	48	137.28	146.98
5914			
14 mm	48	44.19	74.10
5928 Steel			
14 mm	12	26.208	45.814
5942			
14 mm	48	103.25	130.56
5944			
14 mm	48	83.24	110.32
5948 Steel			
14 mm	12	27.216	46.822
5954			
14 mm	48	66.45	82.96
7800			
Nr. 646	100	–	–
Nr. 647	1,000	–	–
40512			
12 mm	12	25.4	42.8
40515			
15 mm	12	45.4	61.6
40519			
19 mm	6	45.1	62.2

